



Investor Presentation – March 2025

NASDAQ:PPTA

TSX:PPTA

# Perpetua Resources

Responsible Mining.

Critical Resources.

Clean Future.



# FORWARD-LOOKING STATEMENTS

Information and statements contained in this presentation that are not historical facts are “forward-looking information” or “forward-looking statements” (collectively, “Forward-Looking Information”) within the meaning of applicable Canadian securities legislation and the United States Private Securities Litigation Reform Act of 1995. We use words such as “may,” “would,” “could,” “should,” “will,” “likely,” “expect,” “anticipate,” “believe,” “intend,” “plan,” “forecast,” “outlook,” “project,” “estimate” and similar expressions suggesting future outcomes or events to identify forward-looking statements or forward-looking information. Forward-Looking Information includes, but is not limited to, information concerning the business of Perpetua Resources Corp. (the “Company”), the Stibnite Gold Project (the “Project”), including but not limited to statements with respect to results of the FS (as defined below) and the Financial Update (as defined below); the assumptions, qualifications and limitations of the results of the FS and the Financial Update, including the economic results and the sensitivity analysis of the variables included therein; other assumptions underlying the FS and the Financial Update, including regarding inflation, labor, regulatory and permitting outcomes and timing, construction timing, production capacity and expectations, LOM estimates, expected mining methods; the expected outcomes of the Stibnite Gold Project, including our reserves and resources; disclosure regarding possible events, conditions or financial performance that is based on assumptions about future economic conditions and courses of action; next steps and courses of action including the prospects and timing of successfully securing project financing on acceptable terms, or at all; environmental clean up actions by us and our contractors; ongoing funding and anticipated liquidity; our ability to comply with and obtain permits related to the Stibnite Gold Project; actions to be taken by the USFS, the Department of Defense, the State of Idaho and other government agencies and regulatory bodies; our ability to successfully implement and fund the Project and the occurrence of the expected benefits from the Project; timing of anticipated milestones related to the Project; predictions regarding improvements to water quality, water temperature, and fish habitats and other environmental conditions at the site, including with respect to process and timing of such improvements; reduction of the Project footprint and the anticipated benefits and other effects thereof; our ability to successfully implement the Project and the occurrence of the expected benefits from the Project, including contributions to the workforce, national security and clean energy transition; our and Ambri, Inc.’s (“Ambri”) ability to perform under the supply agreement described in this presentation, which agreement is subject to certain conditions, including completion of the permitting process for the Project, commencement of commercial production of antimony, identification of one or more refiners to transform our antimony concentrate into antimony metal, and mutual agreement on certain material terms, including volume and pricing; the anticipated economic, environmental and other benefits of the Project; the viability of the Project; development and operating costs in the event that a production decision is made; success of exploration, development and environmental protection, closure and remediation activities; permitting time lines and requirements; requirements for additional capital; requirements for additional water rights and the potential effect of proposed notices of environmental conditions relating to mineral claims; risks and opportunities associated with the Project; planned exploration and development of properties and the results thereof; planned expenditures, production schedules and budgets and the execution thereof. Statements concerning mineral resource and mineral reserve estimates may also constitute Forward-Looking Information to the extent that they involve estimates of the mineralization that may be encountered if the Project is developed. In preparing the Forward-Looking Information herein, the Company has applied several material assumptions, including, but not limited to, assumptions that the conclusions and findings from the FS and basic engineering work, and the technical, geologic, engineering, production and reserve assumptions underlying such work, are reliable to form the basis for the Financial Update; the full amount of the Defense Production Act award will be funded on the expected timeline; that we will be able to obtain sufficient funding to finance permitting, pre-construction and construction of the Project and that all requisite information will be available in a timely manner; the exchange rates for the U.S. and Canadian currencies will be consistent with the Company’s expectations; that the current exploration, development, environmental and other objectives concerning the Project can be achieved and that its other corporate activities will proceed as expected; that the current price and demand for gold and antimony will be sustained or will improve; that general business and economic conditions will not change in a materially adverse manner and that all necessary governmental approvals for planned activities on the Project will be obtained in a timely manner and on acceptable terms; that permitting and operations costs will not materially increase; the continuity of the price of gold and other metals, economic and political conditions and operations; and the assumptions set out in the FS and Financial Update and in the Company’s public filings with the U.S. Securities and Exchange Commission (the “SEC”) and its Canadian disclosure record. Forward-Looking Information involves known and unknown risks, uncertainties and other factors which may cause the actual results, performance or achievements of the Company to be materially different from any future results, performance or achievements expressed or implied by the Forward-Looking Information. Such risks and other factors include, among others, the industry-wide risks and project-specific risks identified in the Technical Reports (as defined below) and the Company’s public filings; operations and contractual obligations; changes in exploration programs based upon results of exploration; failure of mining methods or processes to operate as anticipated; changes in estimated mineral reserves or mineral resources or unexpected variations in quantity of mineralized material, grade, or recovery rates; changes in commodity prices, exchange rates, interest rates, tax rates, operating or production costs; availability of personnel and equipment; plant, equipment or process failure; accidents, effects of weather and other natural phenomena and other risks associated with the mineral exploration industry; environmental risks, including environmental matters under US federal and Idaho rules and regulations; impact of environmental remediation requirements and the terms of existing and potential consent decrees on the Company’s planned exploration and development activities on the Project; certainty of mineral title; community relations; delays in obtaining governmental approvals or financing; the Company’s dependence on one mineral project; the nature of mineral exploration and mining and the uncertain commercial viability; the Company’s lack of operating revenues; governmental regulations and the ability to obtain necessary licenses and permits; risks related to prior unregistered agreements, transfers or claims and other defects in title to mineral projects; currency fluctuations; changes in environmental laws and regulations and changes in the application of standards pursuant to existing laws and regulations; risks related to dependence on key personnel; risks to employee health and safety and a slowdown or temporary suspension of operations in geographic locations impacted by an outbreak of disease; estimates used in budgeting and financial statements proving to be incorrect; risks related to unforeseen delays in the permitting process (including, but not limited to, future US government shutdowns); risks related to opposition to the Project; risks related to increased or unexpected costs in operations or the permitting process; risks that necessary financing will be unavailable when needed on acceptable terms, or at all; risks related to the outcome of litigation and potential for delay of the Project, as well as those factors discussed in the Company’s public disclosure record. Although the Company has attempted to identify important factors that could affect the Company and may cause actual actions, events or results to differ materially from those described in Forward-Looking Information, there may be other factors that cause actions, events or results not to be as anticipated, estimated or intended. There can be no assurance that Forward-Looking Information will prove to be accurate, as actual results and future events could differ materially from those anticipated in such statements. Because it is not possible to predict or identify all such factors, this list cannot be considered a complete set of all potential risks or uncertainties. Accordingly, readers should not place undue reliance on Forward-Looking Information. For further information on these and other risks and uncertainties that may affect the Company’s business and liquidity, see the “Risk Factors” and “Management’s Discussion and Analysis of Financial Condition and Results of Operations” sections of the Company’s filings with the SEC, are available at [www.sec.gov](http://www.sec.gov) and with the Canadian securities regulators, which are available at [www.sedar.com](http://www.sedar.com). Except as required by law, the Company expressly disclaims any obligation to update the Forward-Looking Information herein..



# CAUTIONARY NOTE & TECHNICAL DISCLOSURE

The presentation has been prepared by Perpetua Resources management and does not represent a recommendation to buy or sell these securities. Investors should always consult their investment advisors prior to making any investment decisions. All references to “dollars” or “\$” shall mean United States dollars unless otherwise specified.

The material scientific and technical information in respect of the Stibnite Gold Project in this presentation, unless otherwise indicated, is based upon information contained in the technical report titled “Stibnite Gold Project, Feasibility Study Technical Report, Valley County, Idaho” dated effective December 22, 2020, and issued January 27, 2021 (the “FS” or “2020 Feasibility Study”). The 2020 Feasibility Study was prepared in accordance with National Instrument 43-101 - Standards of Disclosure for Mineral Projects (“NI 43-101”). NI 43-101 is a rule developed by the Canadian Securities Administrators that establishes standards for all public disclosure of scientific and technical information concerning mineral projects. These standards differ from the mining property disclosure rules specified in Subpart 1300 of Regulation S-K under the United States Securities Act of 1933 (“Subpart 1300”) promulgated by the SEC. Accordingly, information concerning mineral deposits from the 2020 Feasibility Study set forth herein may not be comparable with information made public by companies that report in accordance with U.S. standards.

The Company has issued a Technical Report Summary (the “TRS”), dated as of December 31, 2021, and amended as of June 6, 2022, developed for the Stibnite Gold Project in accordance with the mining property disclosure rules specified in Subpart 1300 promulgated by the SEC. The TRS summarizes, in accordance with the mining property disclosure rules specified in Subpart 1300, the FS, which was completed under NI 43-101, with the following notable differences between the FS and the TRS:

- The TRS Mineral Resource estimates were developed based on a gold price of \$1,500/oz versus the \$1,250/oz gold price assumed for the FS. The change in gold price results from higher trailing average gold prices at the date of preparation for the respective reports.
- The Measured Mineral Resources in the FS were reclassified to Indicated Mineral Resources in the TRS due to differences in Subpart 1300 versus NI 43-101 Mineral Resources classification guidelines.
- The Proven Mineral Reserves from the FS were reclassified as Probable Mineral Reserves for the TRS resulting from the reclassification of the Measured Mineral Resources to Indicated Mineral Resources due to differences in Subpart 1300 versus NI 43-101 Mineral Resources classification guidelines.
- The TRS is classified as a Preliminary Feasibility level study whereas the FS was classified as a Feasibility level study. This change was driven by the Subpart 1300 requirement that a compliant Feasibility level TRS include a capital cost contingency allowance no greater than 10%, whereas the initial capital cost estimate for the FS included a more conservative allowance at approximately 15%.

All other technical analyses, design information, capital and operating cost information, economic analyses, permitting and legal assumptions, conclusions and recommendations are consistent between the TRS and the FS.

Financial data in the FS and TRS are based on cost estimates as of December 31, 2020, as set forth in the FS. On February 13, 2025, the Company released an updated cash flow model for the Project (the “Financial Update”). The Financial Update was prepared by the Company and is based, in part, on the basic engineering work completed by Ausenco Engineering USA South Inc. (“Ausenco”) in January 2025, and with contributions from other mining engineers and consultants, utilities and financial advisors. It is intended to be read as a supplemental financial update to the cash flow forecast included in the FS with respect to economic information regarding the Project. Using the scientific and technical information presented in the FS, the Financial Update reflects the progression of the Project plan to a Basic Engineering level, including applying fourth quarter 2024 cost estimates for construction and operations and current and consensus commodity pricing for sales. Neither the Financial Update nor the studies or data underlying such update modifies the Mineral Resources and Mineral Reserves reported in the FS and the TRS or the material assumptions and information pertaining to such disclosure. The information contained in the Financial Update is subject to the assumptions, exclusions and qualifications set forth in the Company’s Current Report on Form 8-K filed with the SEC on February 13, 2025, as well as those contained in the FS and the TRS, except to the extent explicitly updated by the Financial Update.

Readers are encouraged to read the Financial Update and the Company’s Current Report on Form 8-K filed with the SEC on February 13, 2025, which is available under the Company’s profile on EDGAR. Readers are encouraged to read the TRS and the Company’s Current Report on Form 8-K filed with the SEC on January 3, 2021, as amended by the Company’s Current Report on Form 8-K/A filed with the SEC on June 8, 2022, which are available under the Company’s profile on EDGAR. Readers are also encouraged to read the FS, which is available on the Company’s website and under the Company’s profile on SEDAR, for detailed information concerning the Project. The FS, the TRS and the Financial Update are intended to be read as a whole, and sections should not be read or relied upon out of context. References to the “Technical Reports” in this presentation refer to the FS, the TRS and the Financial Update, as applicable. See also “Regulatory Information” at the end of this presentation.

This presentation contains certain mineral reserve, production, costs, valuation, capitalization, trading data and similar information regarding certain other mineral projects and peer companies. Such data was derived from publicly available reports by such companies and other trade and industry sources. While the company believes such sources to be reliable, the company has not independently verified such information. Furthermore, information regarding mineral reserves, production and similar mineral project information for each company is based on estimates, assumptions and reporting standards applied to available data by each company and their reserve engineers in their respective reports, which may differ materially from the estimates, assumptions and reporting standards applied by us, and therefore may not be comparable among the companies presented. As a result, comparisons of such data made in this presentation, while considered reasonable at the time they are made, are subject to a variety of risks and uncertainties which could cause actual events or results of each company to differ materially from those reflected and there can be no assurance that we will be able to achieve similar results at similar stages of development.

Investors should be aware that the Letter of Interest from US EXIM is non-binding and conditional, and does not represent a financing commitment. A funding commitment is conditional upon completing the application, due diligence and underwriting process and receiving all required Project approvals. Additionally, funding under the DPA TIA is available only for the specified costs related to permitting, environmental baseline data monitoring, environmental and technical studies, and advancing construction readiness and is not available to fund certain corporate expenses.



# WHY PERPETUA RESOURCES?

*World class gold-antimony project and national strategic asset*

## World Class Gold Project<sup>1</sup>

4.8 Moz reserve

~460 Koz/yr in first 4 yrs

Exploration upside

## Lowest Quartile Costs<sup>1,2</sup>

Low strip ratio

Low-cost, clean hydro power

Antimony by-product credit

## Restoring Brownfield Site

Environmental solutions integrated into plan of operations

Re-establish fish migration and improve habitat conditions

## Critical Mineral

Only U.S. reserve of antimony<sup>3</sup>

Antimony is critical to national defense and clean energy future

## Government Interest

~\$75 million Department of Defense Awards<sup>4</sup>

~\$1.8 billion indicative U.S EXIM financing<sup>5</sup>

## Next Catalysts

✓ Jan '25 – Final Record of Decision

H1 '25 – Final Permits, Financing

2025 – Construction Decision

*Idaho: A Premier Mining Jurisdiction*

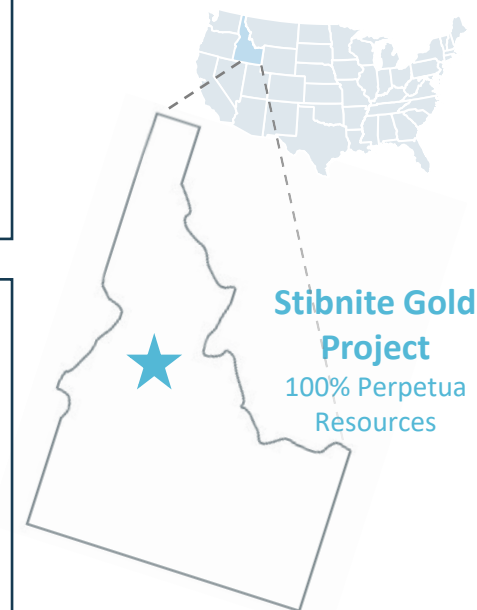

<sup>1</sup>Based on the FS and Financial Update, which are intended to be read as a whole, and sections should not be read or relied upon out of context. Financial data as of Q4 2024 as set forth in the Financial Update. The information in this presentation is subject to the assumptions, exclusions and qualifications contained in the Technical Reports. See "Cautionary Note and Technical Disclosure" at the beginning of this presentation.

<sup>2</sup>Based on the latest global all-in sustaining cost information available on the World Gold Council website, [www.worldgoldcouncil.org](http://www.worldgoldcouncil.org) (Source: Metals Focus Gold Mine Cost Service).

<sup>3</sup>Source: U.S. Geological Survey, Mineral Commodity Report Summaries, January 2024.

<sup>4</sup>Includes Small Business Innovation Research Grants of \$200K, Defense Ordnance Technology Consortium Agreement of up to \$15.5 million and Defense Production Act Title III funding of \$59.2 million. See Cautionary Note.

<sup>5</sup>Based on a Letter of Interest from US EXIM, which indicated EXIM may be able to consider potential financing of up to \$1.8 billion based on the preliminary information submitted regarding expected U.S. exports and U.S. jobs supported by the Project. Any final commitment will be dependent on meeting EXIM's underwriting criteria, authorization process, finalization and satisfaction of terms and conditions. All final commitments must comply with EXIM policies as well as program, legal and eligibility requirements. See Cautionary Note.



# THE STIBNITE GOLD PROJECT

Our goal is to transform an area abandoned after 100 years of mining activity into a national strategic asset for critical mineral and gold production through responsible mining and a sustainable approach to restore the environment for the benefit of all stakeholders.



# PERPETUA'S COMPETITIVE ADVANTAGE<sup>1</sup>

*The Stibnite Gold Project can deliver long term solutions and sustained value for all stakeholders*

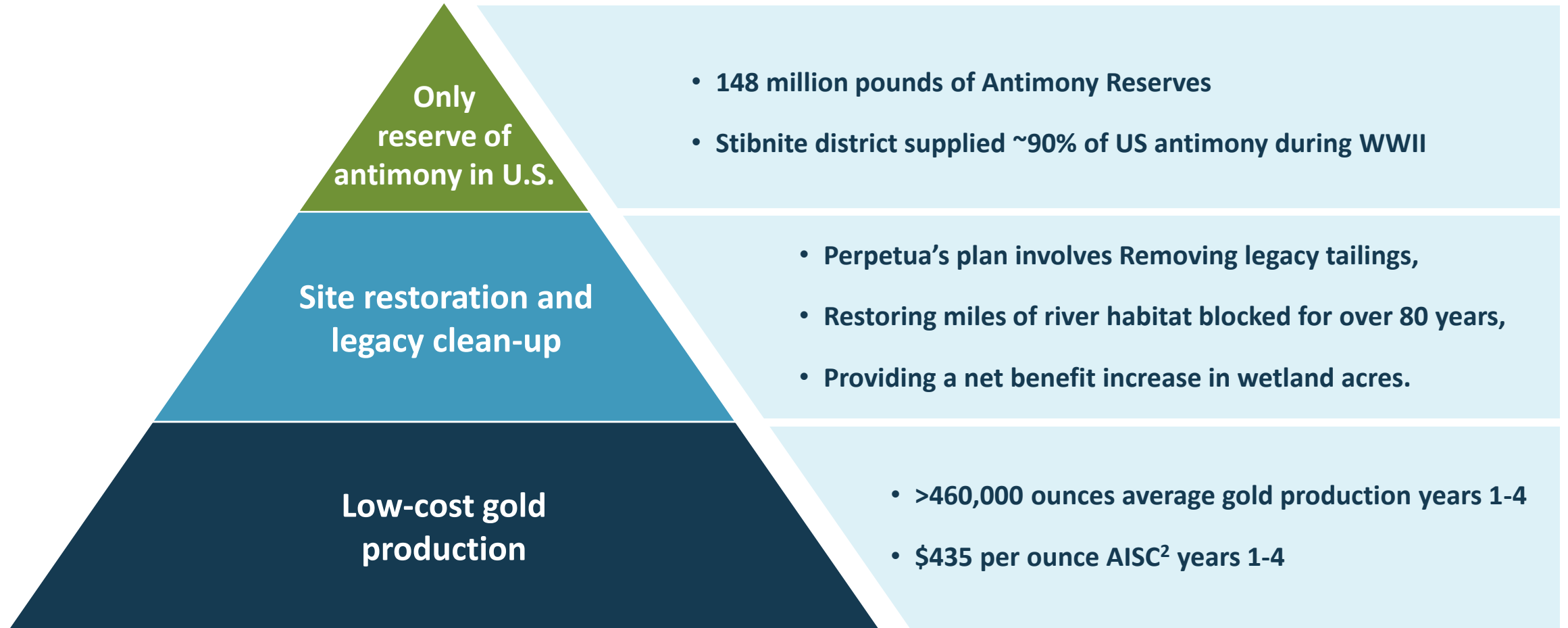

<sup>1</sup>Based on the FS and Financial Update, which are intended to be read as a whole, and sections should not be read or relied upon out of context. Financial data as of Q4 2024 as set forth in the Financial Update. The information in this presentation is subject to the assumptions, exclusions and qualifications contained in the Technical Reports. See "Cautionary Note and Technical Disclosure" at the beginning of this presentation.

<sup>2</sup>See Non-GAAP Measures at the end of this presentation for further information.



# LARGEST INDEPENDENT<sup>1</sup> U.S. GOLD RESERVE



Source: Latest available company materials as of December 2024.

1. Independent refers to gold projects as not owned by Barrick or Newmont; Independent projects shown are from the lower 48 states in the U.S.

2. Based on the FS, which is intended to be read as a whole, and sections should not be read or relied upon out of context. The information in this presentation is subject to the assumptions, exclusions and qualifications contained in the Technical Reports. See "Cautionary Note and Technical Disclosure" at the beginning of this presentation.

3. Open Pit Reserves only.



# HIGH-GRADE, OPEN PIT GOLD DEPOSIT

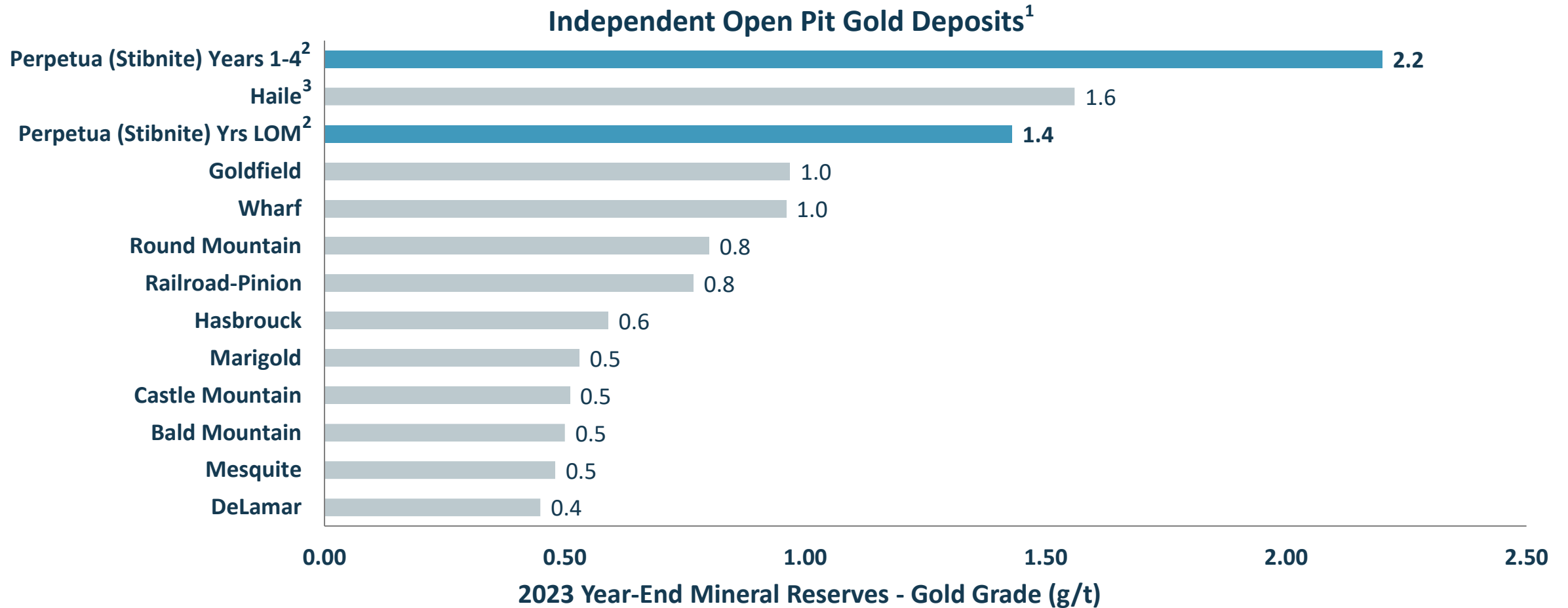

Source: Latest available company materials as of December 2024.

1. Independent refers to gold projects as not owned by Barrick or Newmont; Independent projects shown are from the lower 48 states in the U.S.

2. Based on the FS, which is intended to be read as a whole, and sections should not be read or relied upon out of context. The information in this presentation is subject to the assumptions, exclusions and qualifications contained in the Technical Reports.

See "Cautionary Note and Technical Disclosure" at the beginning of this presentation.

3. Open Pit Reserves only.





# POISED TO BE ONE OF LARGEST U.S. GOLD MINES

## Independent Projects and Producing Gold Mines<sup>1</sup>

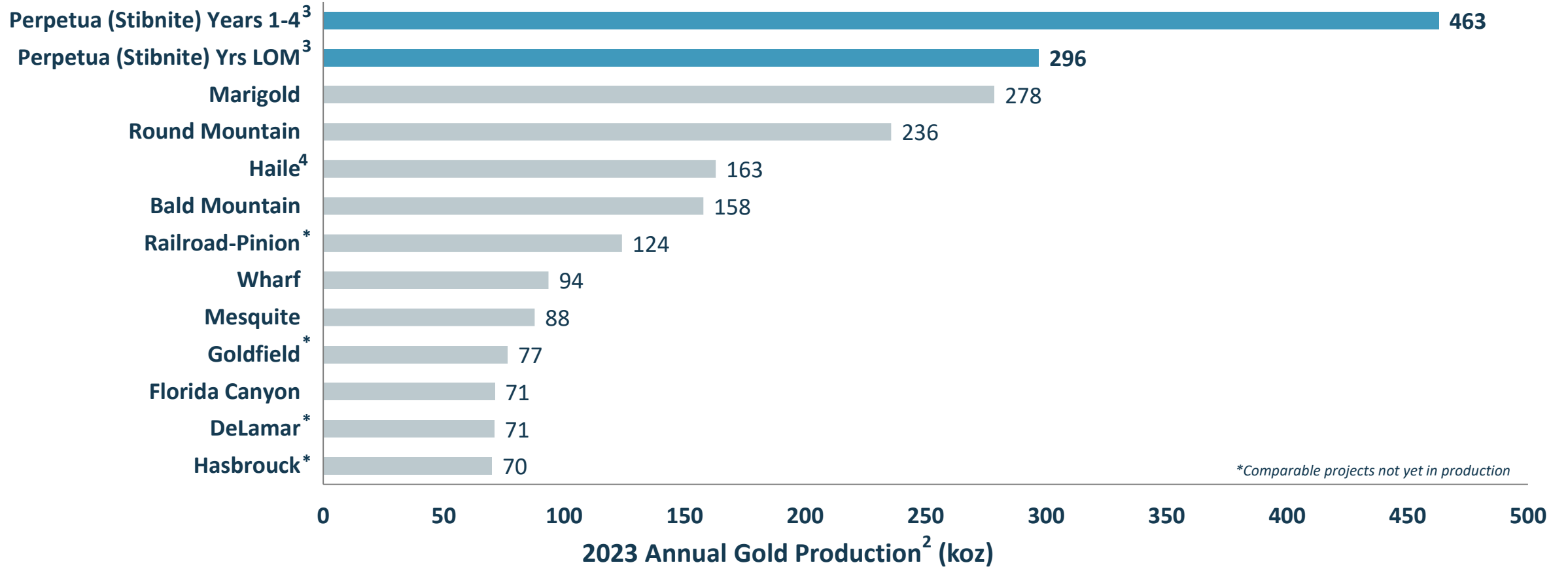

Source: Latest available company materials as of December 2024.

1. Independent refers to gold projects as not owned by Barrick or Newmont; Independent projects shown are from the lower 48 states in the U.S.

2. 2023 annual gold production for the peer group producing mines; future life-of-mine average annual production for the Railroad-Pinion, Goldfield, DeLamar, and Hasbrouck projects based on the most recent technical studies available; Perpetua (Stibnite) is based on estimated future production from the 2020 Feasibility Study.

3. Based on the FS, which is intended to be read as a whole, and sections should not be read or relied upon out of context. The information in this presentation is subject to the assumptions, exclusions and qualifications contained in the Technical Reports. See "Cautionary Note and Technical Disclosure" at the beginning of this presentation.

4. Open Pit part of the project only.



# INDUSTRY LEADING ALL-IN SUSTAINING COSTS<sup>1</sup>

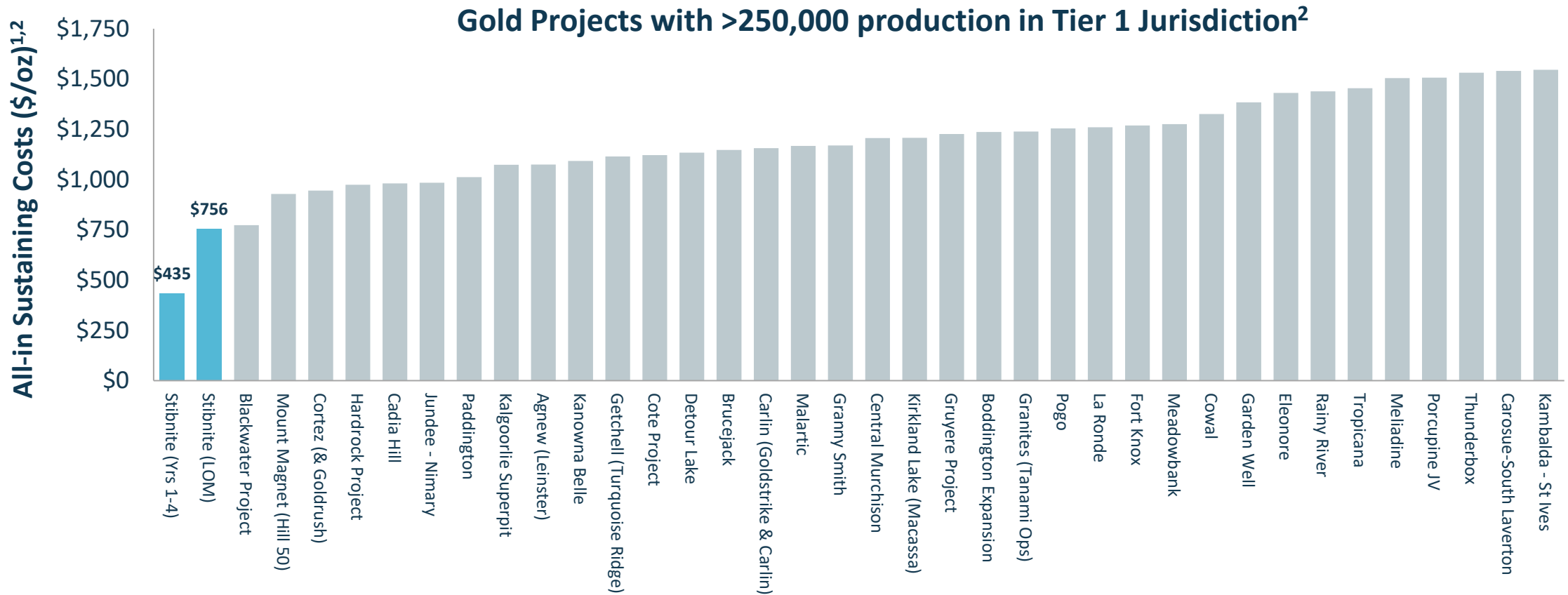

**Valuable antimony by-product credit of \$220/oz over life of mine<sup>3</sup>**

1. All-in Sustaining Cost ("AISC") is a non-GAAP measure. See "Non-GAAP measures" at the end of this presentation.  
 2. Based on a comprehensive list of gold projects in the United States, Canada and Australia with over 250,000 ounces of gold production expected in 2025 from Wood Mackenzie as of December 2024.  
 3. Based on the FS and Financial Update, which are intended to be read as a whole, and sections should not be read or relied upon out of context. Financial data as of Q4 2024 as set forth in the Financial Update. The information in this presentation is subject to the assumptions, exclusions and qualifications contained in the Technical Reports. See "Cautionary Note and Technical Disclosure" at the beginning of this presentation. Antimony by-product credit is calculated using antimony price of \$10.00/lb.



# DEEP DISCOUNT AND LEVERAGE TO GOLD PRICE

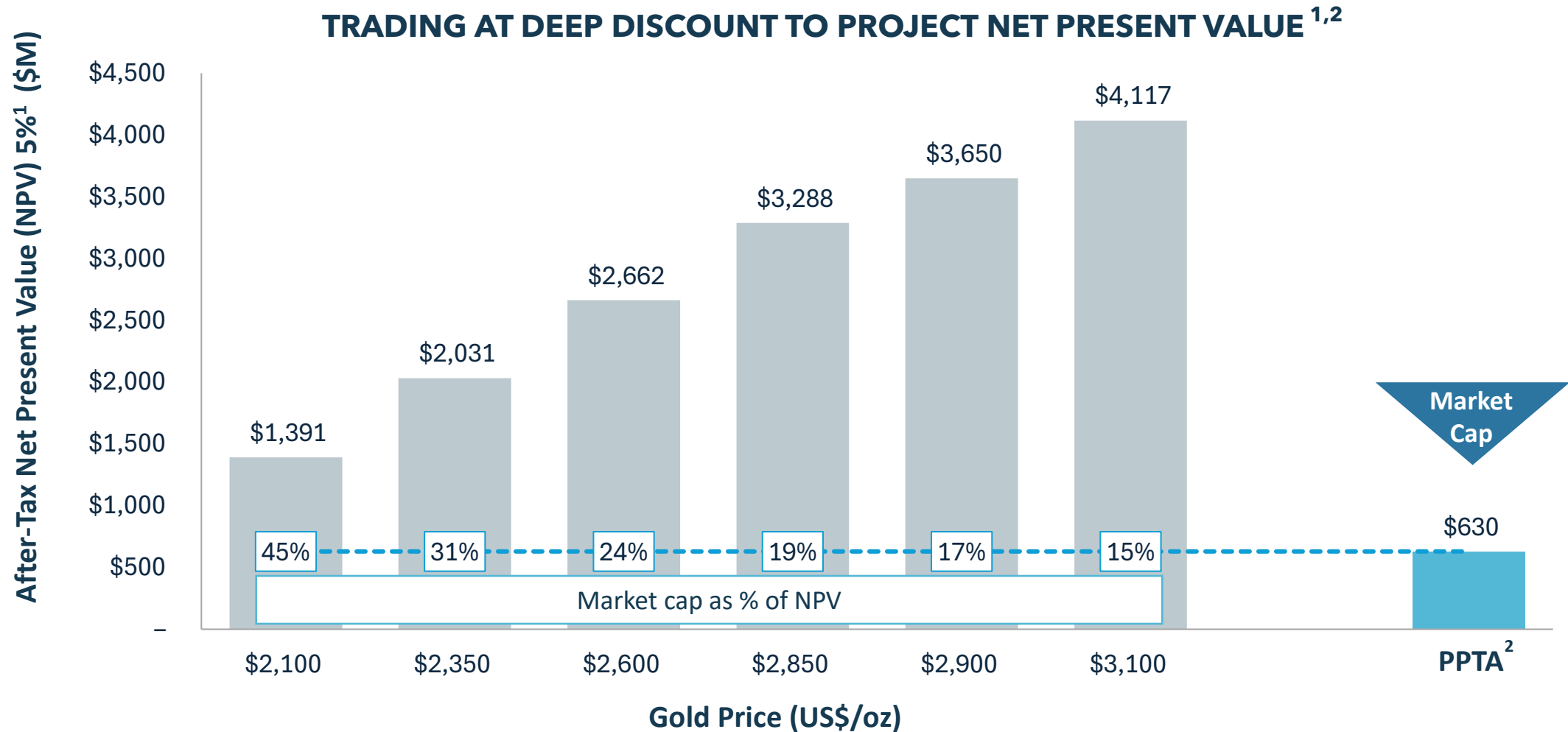

1. Based on the FS and Financial Update, which are intended to be read as a whole, and sections should not be read or relied upon out of context. Financial data as of Q4 2024 as set forth in the Financial Update. The information in this presentation is subject to the assumptions, exclusions and qualifications contained in the Technical Reports. See "Cautionary Note and Technical Disclosure" at the beginning of this presentation.

2. Please refer to "Feasibility Study – Highlights" for further detail on NPV assumptions.

3. Perpetua Resources market cap based on fully diluted market cap using closing price as of February 28, 2025 (US\$8.58 share price and fully diluted shares of 73 million).



# RESTORING AN ABANDONED BROWNFIELDS SITE

## ENVIRONMENTAL SOLUTIONS FUNDED THROUGH MINE DEVELOPMENT

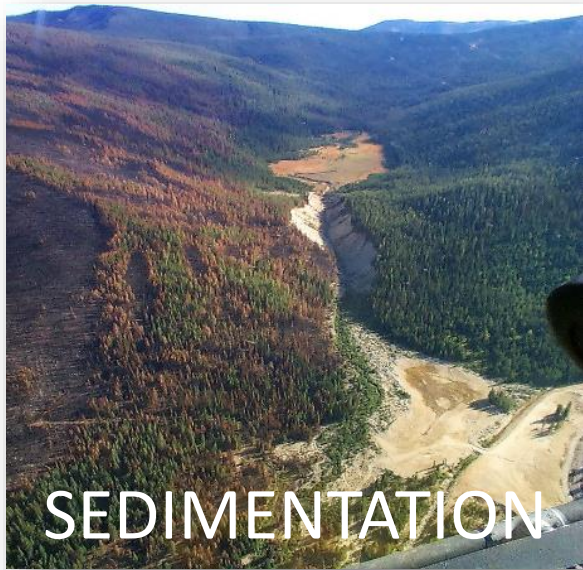

Early repair of the largest source of sedimentation



Pick up, reprocess, reuse and safely store 10.5M tons of tailings and spent ore



Re-establish fish migration and provide temporary and permanent river restoration



# ESTABLISHING A NATIONAL STRATEGIC ASSET

## ANTIMONY - IT'S CRITICAL

- ✓ Essential to economic and national security
- ✓ U.S. has no domestic mined production
- ✓ Clean energy & national defense applications
- ✓ China & Russia dominate the world supply (>70%)
- ✓ China to begin antimony export controls in 2024

World Antimony 2022 Production (usgs)

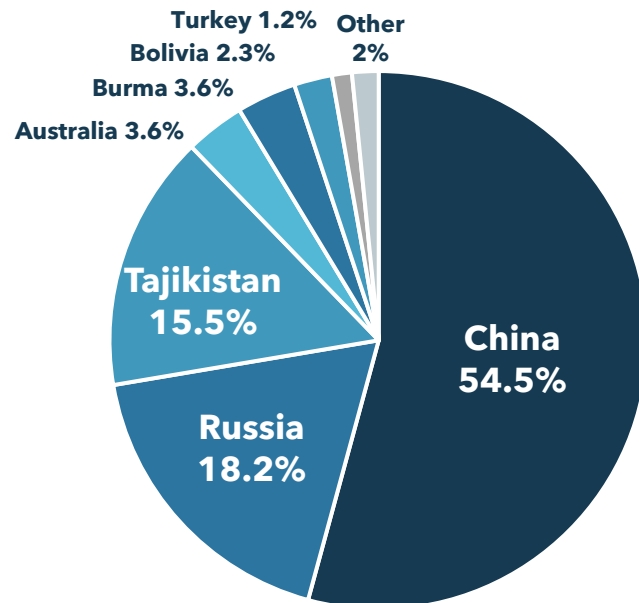

Other countries that produce less than 1% of global supply: Mexico, Iran, Vietnam, Kazakhstan, Guatemala, Pakistan, Canada

## USES FOR ANTIMONY





# EXPECTED TO AVERAGE ~35% OF U.S. DEMAND<sup>1,2</sup>

## Stibnite Gold Project Recovered Antimony<sup>2</sup>

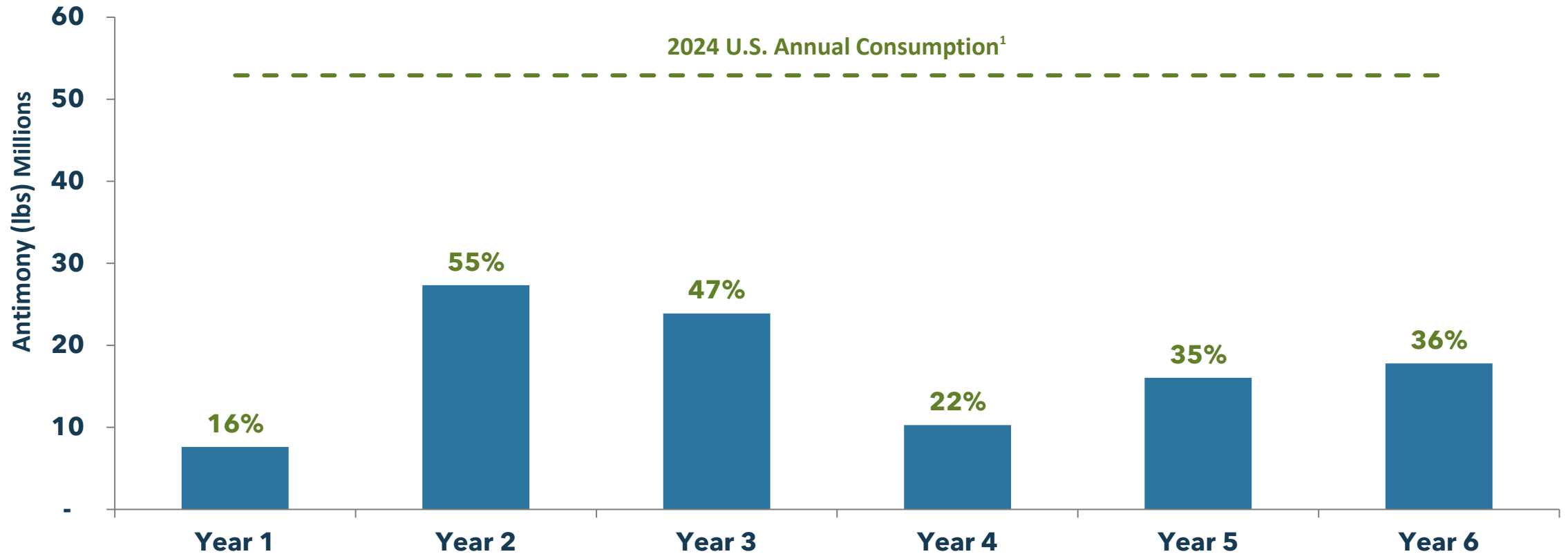

**Perpetua Resources plans to re-establish domestic antimony production, protecting America's future**

1. Source: 2024 USGS Antimony commodity summary, January 2025

2. Based on the FS, which is intended to be read as a whole, and sections should not be read or relied upon out of context. The information in this presentation is subject to the assumptions, exclusions and qualifications contained in the Technical Reports. See "Cautionary Note and Technical Disclosure" at the beginning of this presentation.



# WHOLE OF GOVERNMENT APPROACH

**\$1.8**

**Billion<sup>1</sup>**

**Indication of up to \$1.8B  
from Export-import Bank Of  
The United States for  
Stibnite Gold Project  
financing**



**\$75**

**Million<sup>2</sup>**

**Critical minerals awards,  
combined, to advance antimony  
research, construction  
readiness, permitting, and  
engineering**



U.S. Department of Defense

**8+**

**Years**

**Interagency permitting review  
with robust stakeholder  
engagement and improved  
environmental outcomes**



1. Based on a Letter of Interest from US EXIM, which indicated EXIM may be able to consider potential financing of up to \$1.8 billion based on the preliminary information submitted regarding expected U.S. exports and U.S. jobs supported by the Project. Any final commitment will be dependent on meeting EXIM's underwriting criteria, authorization process, finalization and satisfaction of terms and conditions. All final commitments must comply with EXIM policies as well as program, legal and eligibility requirements. See Cautionary Note.

2. Includes Small Business Innovation Research Grants of \$200K, Defense Ordnance Technology Consortium Agreement of up to \$15.5 million and Defense Production Act Title III funding of \$59.2 million. See Cautionary Note.



# PATH FORWARD FOR THE STIBNITE GOLD PROJECT\*

*Remaining Ancillary Permits, Project Financing and Development Activities Anticipated in 2025*

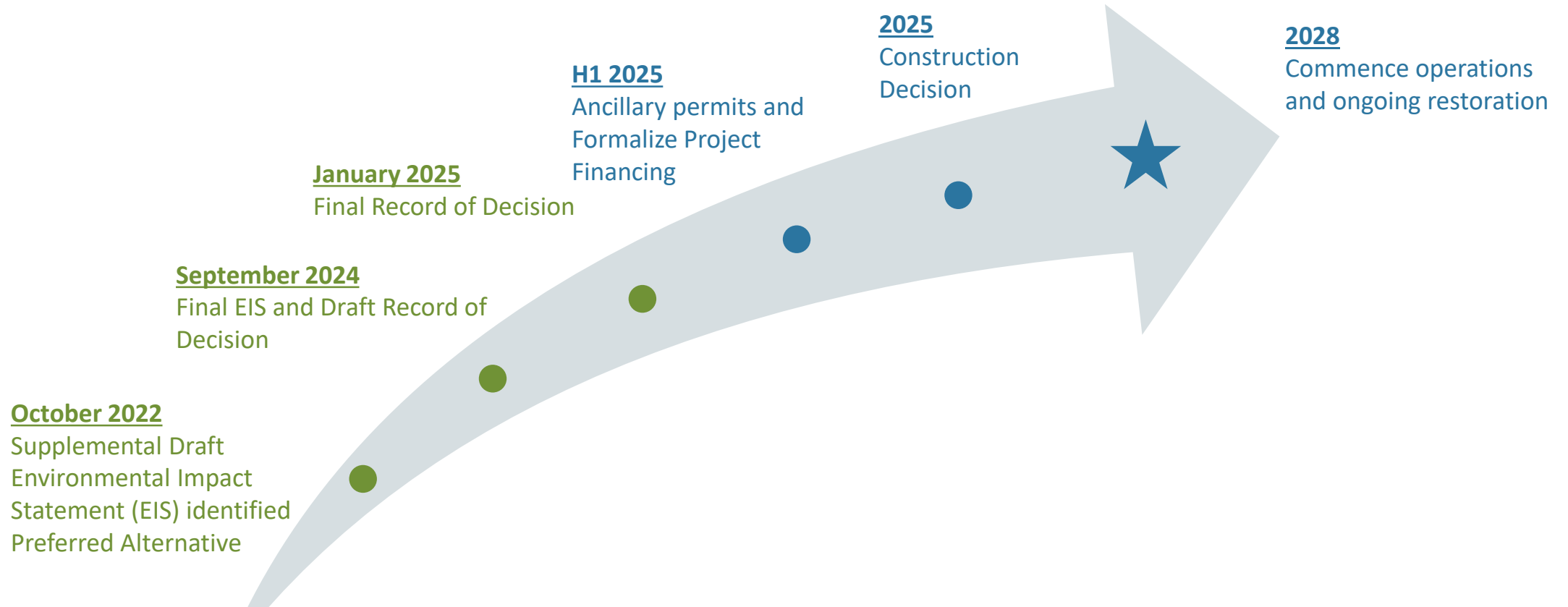

**Final Record of Decision authorizes Perpetua's proposed mine plan\***

\*See forward-looking statements at the beginning of this presentation. Based on the latest permitting agency schedules and management expectations.



# GAINING MOMENTUM WITH NEAR-TERM CATALYSTS

## 2024 Recap:

- ✓ Announced Jon Cherry as new President & CEO (Mar 2024)
- ✓ Received up to \$1.8 billion indication for financing from U.S. EXIM (Mar 2024)
- ✓ Awarded additional \$34.4 million under the DPA (May 2024)
- ✓ China announces export controls on antimony (Aug, Dec 2024)
- ✓ Engaged advisors to assist evaluation of potential strategic and financing opportunities (Sep 2024)
- ✓ Final Environmental Impact Statement & Draft Record of Decision (Sep 2024)

## Permitting & Development Milestones<sup>1</sup>:

- ✓ Final Record of Decision (Jan 2025)
- Ancillary permits & formalize financing (H1 2025)<sup>2</sup>
- Construction start (2025)
- Commence operations, ongoing restoration (2028)

## CEO Spotlight:

- Joined Perpetua in March 2024
- 35+ years permitting, mine projects & operations experience in the United States
- *"I look forward to advancing Perpetua's vision to restore an abandoned legacy mine site, responsibly develop one of the highest grade open-pit gold mines in the United States and support national security..."*
- *"This Final Record of Decision elevates the Stibnite Gold Project to an elite class of projects in America that have cleared NEPA."*



<sup>1</sup> See forward-looking statements at the beginning of this presentation.

<sup>2</sup> Based on the latest permitting agency schedules and management expectations.

# VALUATION EXPECTED TO INCREASE THROUGH NEXT PHASE

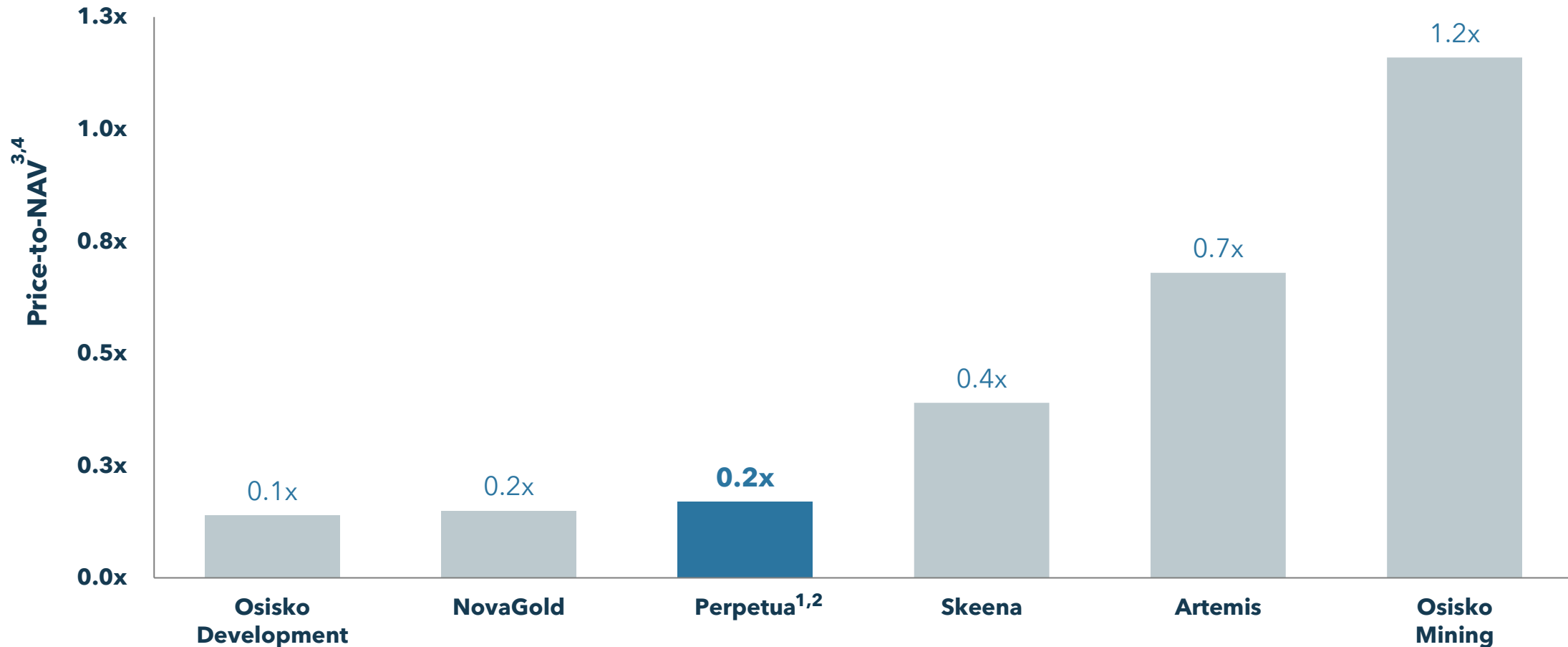

1. Perpetua Resources market cap based on fully diluted market cap using closing price as of February 28, 2025 (US\$8.58 share price and fully diluted shares of 73 million).

2. Based on the FS and Financial Update, which are intended to be read as a whole, and sections should not be read or relied upon out of context. Financial data as of Q4 2024 as set forth in the Financial Update. The information in this presentation is subject to the assumptions, exclusions and qualifications contained in the Technical Reports. See "Cautionary Note and Technical Disclosure" at the beginning of this presentation.

3. NAV's based on after-tax NPV (5% discount rate) based on last available NAV assuming Spot prices. Spot prices are defined as \$2,900/oz gold, \$21.00/lb antimony, and \$31.50/oz silver. The precious metals prices selected for this scenario were based on the NYMEX gold and silver settlement prices of \$2,887.60/oz and \$32.44/oz, respectively, on February 7, 2025. The antimony price selected for the spot scenario was based on Rotterdam antimony price as of February 7, 2025. Refer to "Non-GAAP Measures" for further information.

4. Market Caps based on February 28, 2025 closing stock prices.

5. Note: The valuation for Osisko Mining is based on transaction multiples implied by the transaction announced on August 12, 2024.



# A UNIQUE AMERICAN OPPORTUNITY



- ✓ Redeveloping one of **largest, highest grade**, and **lowest cost** gold projects in the U.S.\*
- ✓ **Superior project economics** with ~15 year reserve life and ~3 year payback period\*
- ✓ **Establishing a national strategic asset** with a **critical mineral** essential for national defense and the **clean energy transition**
- ✓ Located in **stable mining jurisdiction** with **Idaho community** and **political support**
- ✓ **Sustainable approach** to restoring the environment, improving a legacy, and creating value for all stakeholders
- ✓ **Attractive valuation** with **significant near-term catalysts**

*\*Based on the FS and Financial Update, which are intended to be read as a whole, and sections should not be read or relied upon out of context. Financial data as of Q4 2024 as set forth in the Financial Update. The information in this presentation is subject to the assumptions, exclusions and qualifications contained in the Technical Reports. See "Cautionary Note and Technical Disclosure" at the beginning of this presentation.*



**Perpetua  
Resources**  
CORP.

# Appendix



# RIGHT LEADERSHIP FOR THE NEXT PHASE

## EXECUTIVE TEAM



**Jon Cherry**  
Board Director & CEO



**Jessica Largent**  
Board Director & CFO



**Mckinsey Lyon**  
VP, External Affairs



**Alan Haslam**  
VP, Permitting



**Michael Wright**  
VP, Projects



**Laurel Sayer**  
Senior Advisor to CEO

## CORPORATE BOARD



**Marcelo Kim**  
Chairman  
Paulson & Co



**Andy Cole**  
Director  
Former NovaGold &  
Barrick



**Bob Dean**  
Director  
Former Allen &  
Company



**Laura Dove**  
Director  
Former Ford Motor  
Company, Secretary  
for the Majority of the  
U.S. Senate



**Rich Haddock**  
Director  
Former Barrick



**Jeff Malmen**  
Director  
Idaho Power, Former  
Chief of Staff  
Governor Otter



**Chris Robison**  
Director  
Former Newmont,  
Rio Tinto Minerals  
& Kennecott  
Utah Copper



**Alex Sternhell**  
Director  
Sternhell Group,  
Democrat Dpty. Staff  
Director U.S. Senate  
Cm. Banking



# IDAHO: A PREMIER MINING JURISDICTION

- Well-defined permitting process
- Substantial **community and political support**
- **Low** geopolitical risk
- Strong **infrastructure & low-cost power**
- Talented & experienced workforce

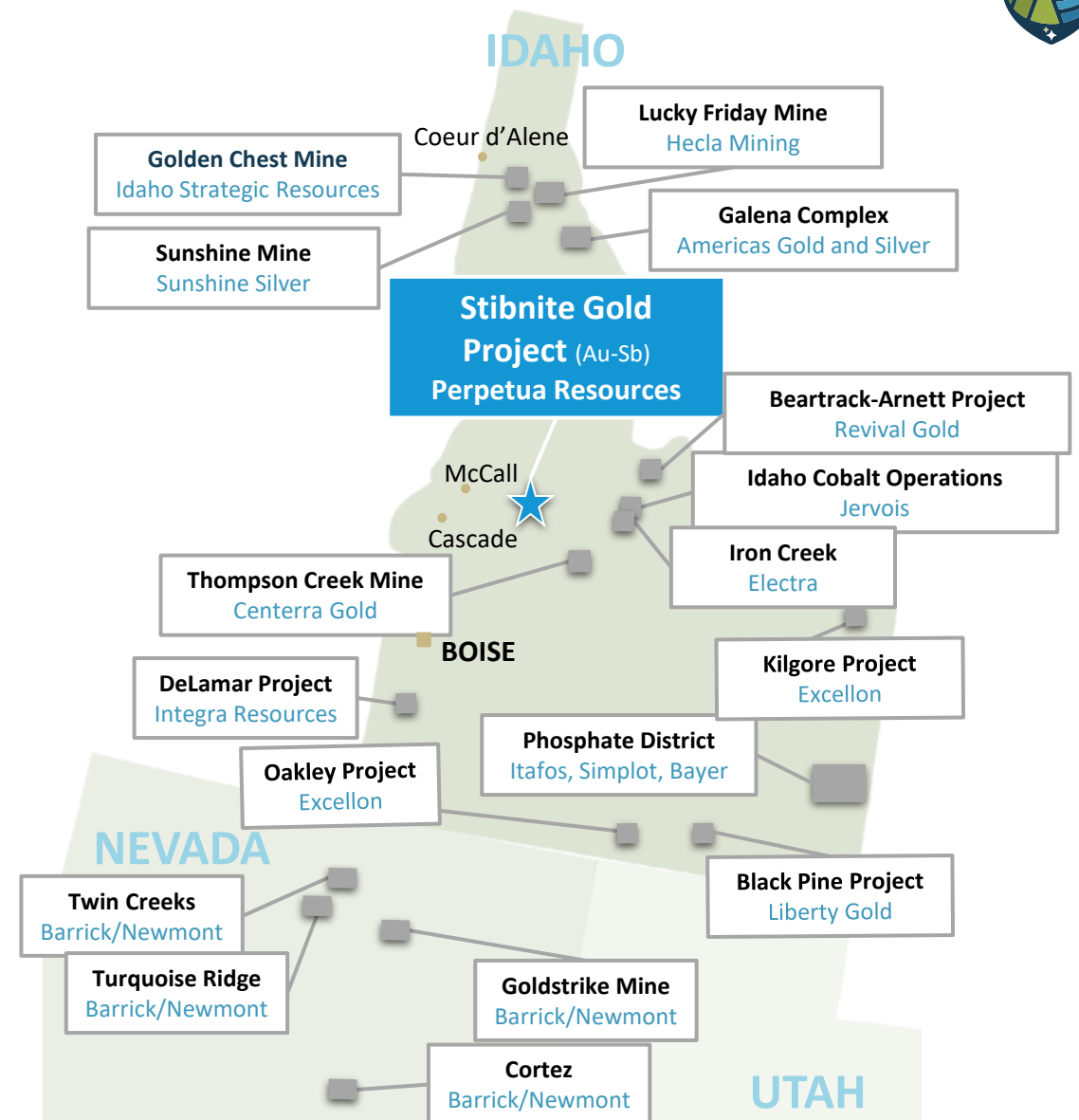



# DEPARTMENT OF DEFENSE AWARDS

*Critical minerals awards of up to \$75 million\* combined to advance antimony research, construction readiness, permitting, and engineering.*

	Demonstrate mil-spec antimony trisulfide		Advance permitting & construction readiness
	SBIR	DOTC	DPA Title III
Program	Small Business Innovation Research Grant (SBIR)	Defense Ordnance Technology Consortium (DOTC)	Defense Production Act Title III (DPA)
Amount	\$200,000 (\$100,000 each)	Up to \$15.5 million	\$59.2 million
Scope	<ol style="list-style-type: none"> <li>1) Test existing samples of antimony trisulfide from the Project for development into military specification (“mil-spec”)</li> <li>2) Study alternative processing opportunities to synthesize mil-spec from high purity antimony metal</li> </ol>	Obtain additional core samples from the Project site, conduct a pilot plant study to produce mil-spec antimony trisulfide, design a full-scale process circuit, and deliver a modular pilot plant for Department of Defense use.	Complete environmental and engineering studies necessary to obtain a Final EIS, a Final Record of Decision, and other ancillary permits. Advance construction readiness.
Government Entity	Defense Logistics Agency & Small Business Innovation Research Lab	DOTC, U.S. Army	U.S. Air Force

*\*Includes Small Business Innovation Research Grants of \$200K, Defense Ordnance Technology Consortium Agreement of up to \$15.5 million and Defense Production Act Title III funding of \$59.2 million. See Cautionary Note.*



# IMPROVING A LEGACY

PLAN DESIGNED WITH POST MINING RESTORATION GOALS IN MIND, INCLUDING WILDLIFE, FISHERIES & DISPERSED RECREATION

- Create a self-sustaining natural environment
- Support healthy fish and wildlife population
- Significant concurrent reclamation & restoration
- Revegetation, reforestation & wetland mitigation
- Address historical impacts from legacy mining
- 10+ year post-operations closure period
- 25 years of water treatment estimated

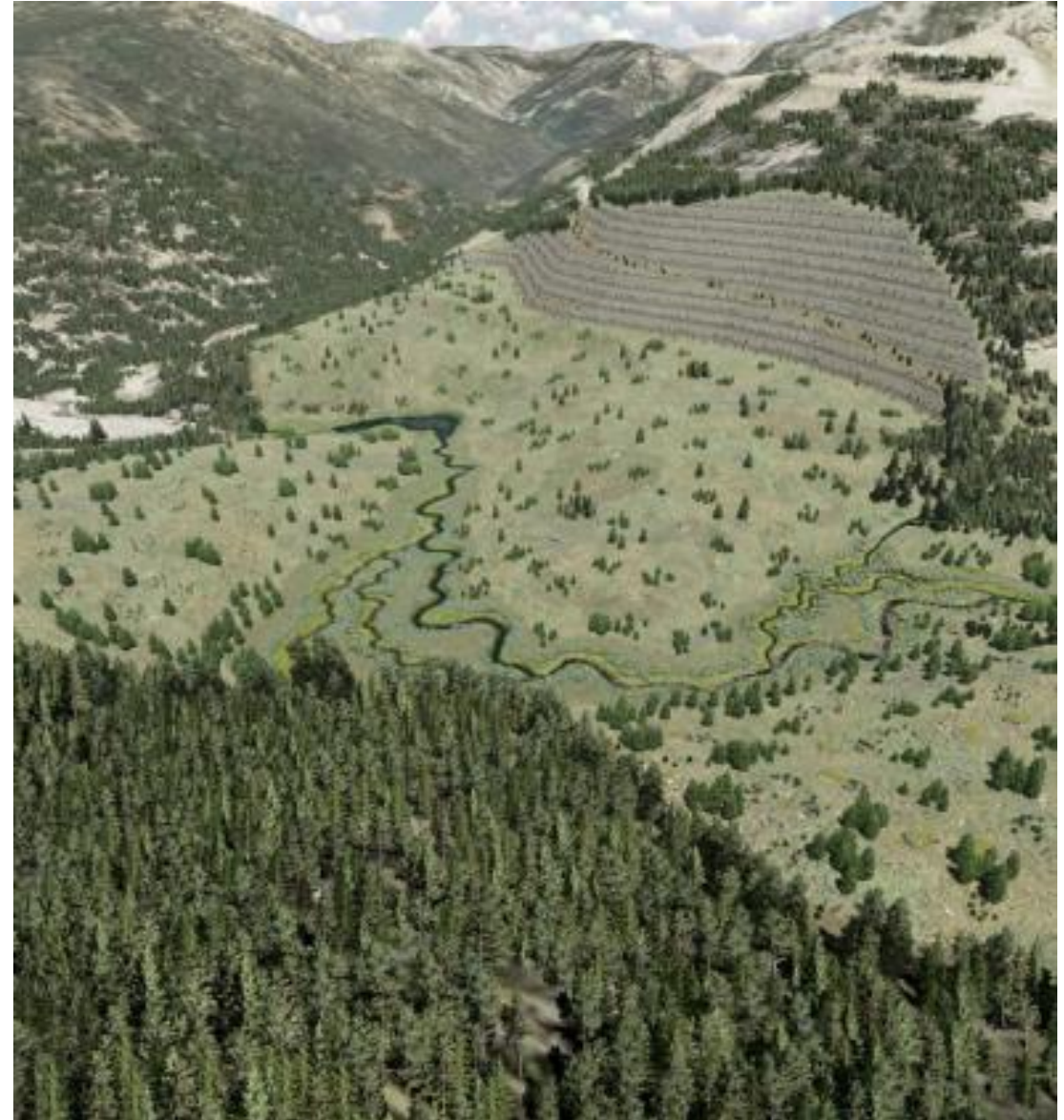

*Based on the FS and Financial Update, which are intended to be read as a whole, and sections should not be read or relied upon out of context. Financial data as of Q4 2024 as set forth in the Financial Update. The information in this presentation is subject to the assumptions, exclusions and qualifications contained in the Technical Reports. See "Cautionary Note and Technical Disclosure" at the beginning of this presentation.*





# PERMITTING – NEXT STEPS

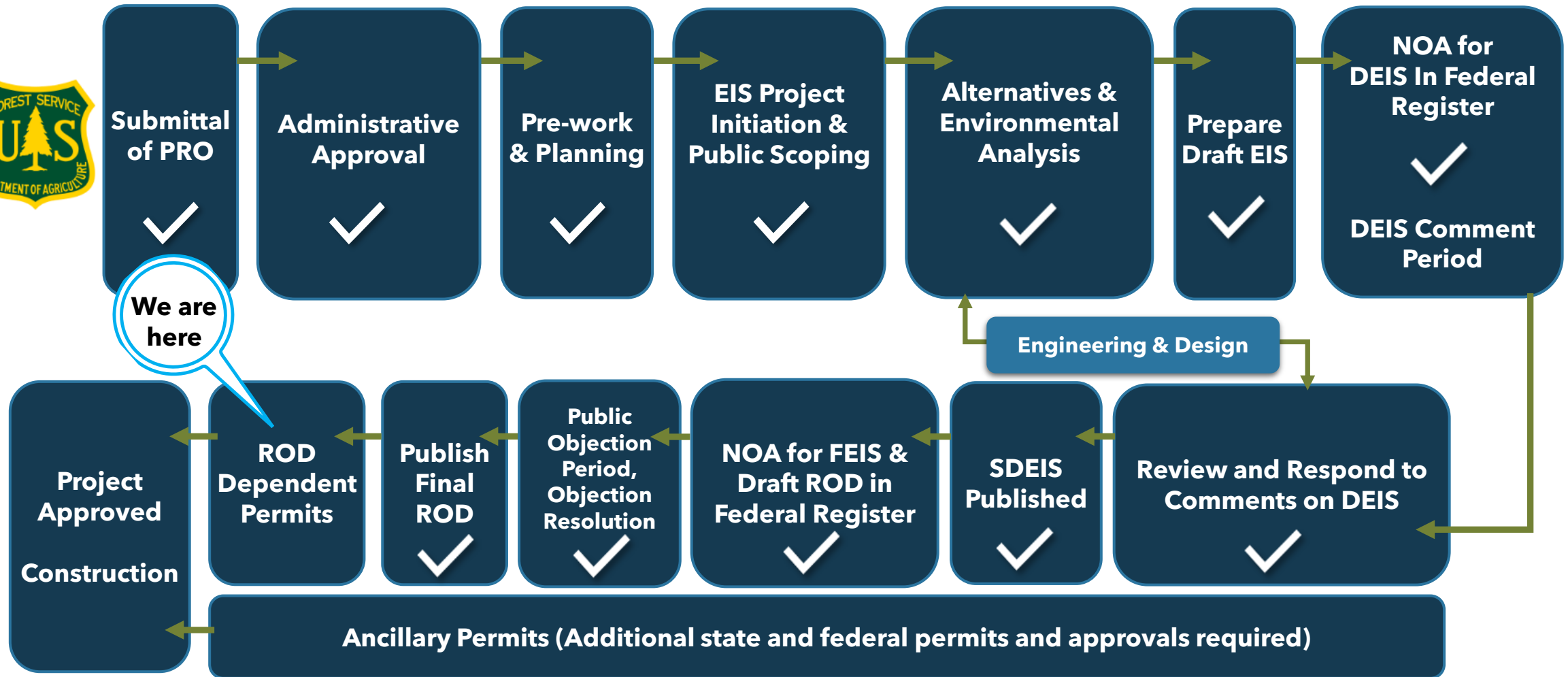

**EIS:** Environmental Impact Statement  
**DEIS:** Draft Environmental Impact Statement  
**FEIS:** Final Environmental Impact Statement

**NOA:** Notice of Availability  
**PRO:** Plan of Restoration and Operations  
**ROD:** Record of Decision



# MINERAL RESOURCES & RESERVES<sup>1</sup>

## Proven & Probable Mineral Reserves<sup>2</sup>:

**4.8 Mozs Gold @1.43 g/t**

148 Mlbs antimony at 0.06% contained in 104 Mt

## Measured & Indicated Mineral Resources<sup>3</sup>:

**6.0 Mozs Gold @1.42g/t**

206 Mlbs antimony at 0.07% contained in 132 Mt

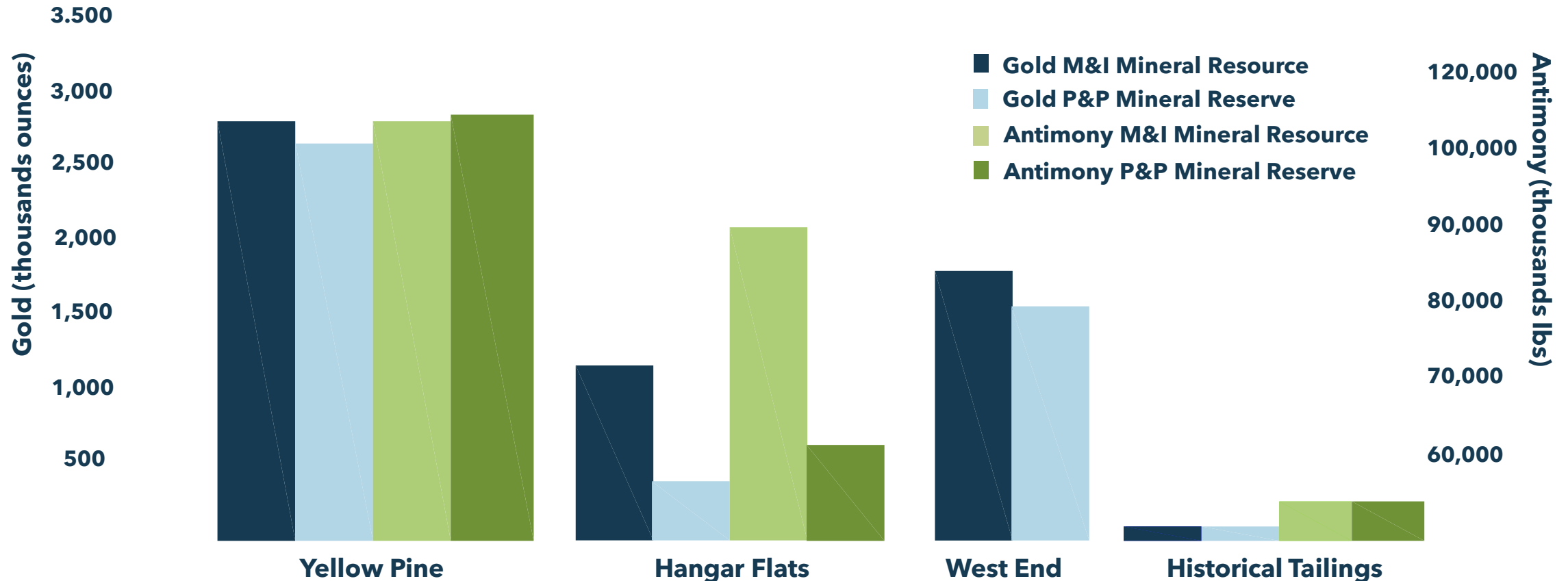

<sup>1</sup> Based on the FS, which is intended to be read as a whole, and sections should not be read or relied upon out of context. The information in this presentation is subject to the assumptions, exclusions and qualifications contained in the Technical Reports. See "Cautionary Note and Technical Disclosure" at the beginning of this presentation. The Mineral Reserves are contained within the Mineral Resources.

<sup>2</sup> Mineral Reserves were calculated using an Au price of \$1600/oz and Sb price of \$3.50/lb and variable cut off grade of 0.39-0.49 g/t Au. The Proven Mineral Reserves from the 2020 FS were reclassified as Probable Mineral Reserves for the TRS.

<sup>3</sup> Mineral Resources were calculated using a \$1250/oz Au price and sulfide cut off grade of 0.45 g/t Au and oxide COG of 0.4 g/t Au based on the 2020 Feasibility Study. Based on a gold price of \$1,500/oz in the TRS, Mineral Resources increased to 6.3Mozs @1.33 g/t using a sulfide cut off grade of 0.40 g/t Au and oxide cut off grade of 0.35 g/tAu. The Measured Mineral Resources from the 2020 FS were reclassified to Indicated Mineral Resources in the TRS due to differences in the S-K 1300 versus NI 43-101 Mineral Resources classification guidelines.



# EXPLORATION UPSIDE\*

## EXPANSIVE LAND PACKAGE

### EXISTING DEPOSITS:

- Northeast of Yellow Pine Deposit
- Below Hangar Flats pit & Old Defense Minerals Exploration Act (DMEA) working area
- West End along strike and at depth

### PRIORITY EXPLORATION TARGETS:

- High grade targets (Garnet, Scout, Upper Midnight)
- Bulk tonnage targets (Cinnamid-Ridgetop, Saddle-Fern, Rabbit)
- Undefined airborne targets (Mule, Salt & Pepper, Blow-out)

### PIPELINE OF ANTIMONY-RICH TARGETS

\* Some of the prospects are conceptual in nature, there has been insufficient exploration to define a mineral resource and it is uncertain if further exploration will result in the target being delineated as a mineral resource. See the section titled "Forward-Looking Statements" at the beginning of this presentation.

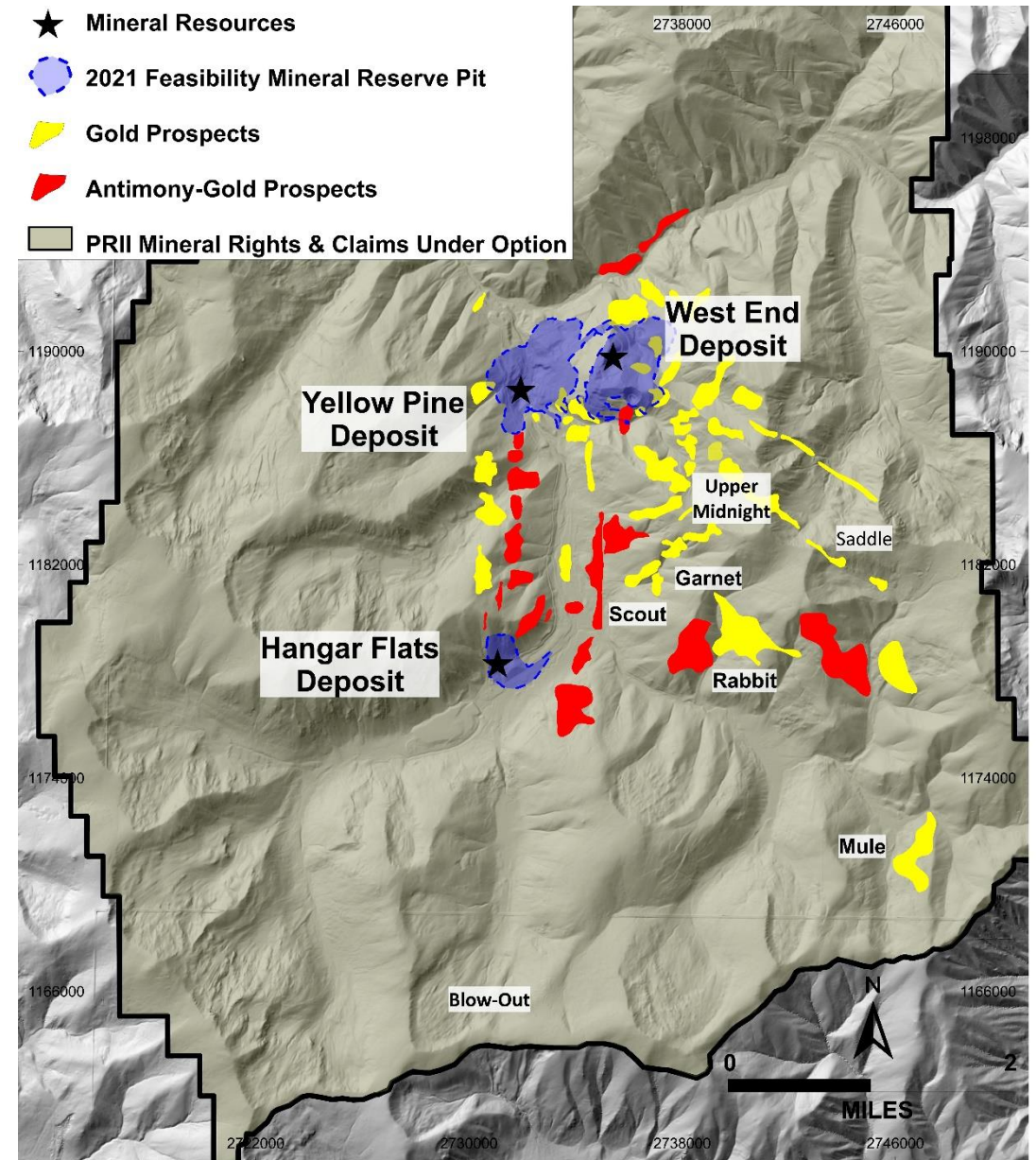



# PERPETUA TO POWER AMBRI'S LOW-COST BATTERY

*Agreement to supply only responsible & domestically mined source of antimony for stationary, long duration, daily cycle energy storage enabling the transition to cleaner energy*

## **SUPPLY AGREEMENT<sup>1</sup>:**

- Current commitment of Perpetua's antimony can power over 13 GWh of energy storage or >8x the total additions to entire U.S. energy storage market in 2020
- Based on standard commercial terms with options for fixed pricing and higher volumes
- Partnering with Ambri to identify opportunities to reduce carbon emissions in operations through renewable energy combined with battery storage

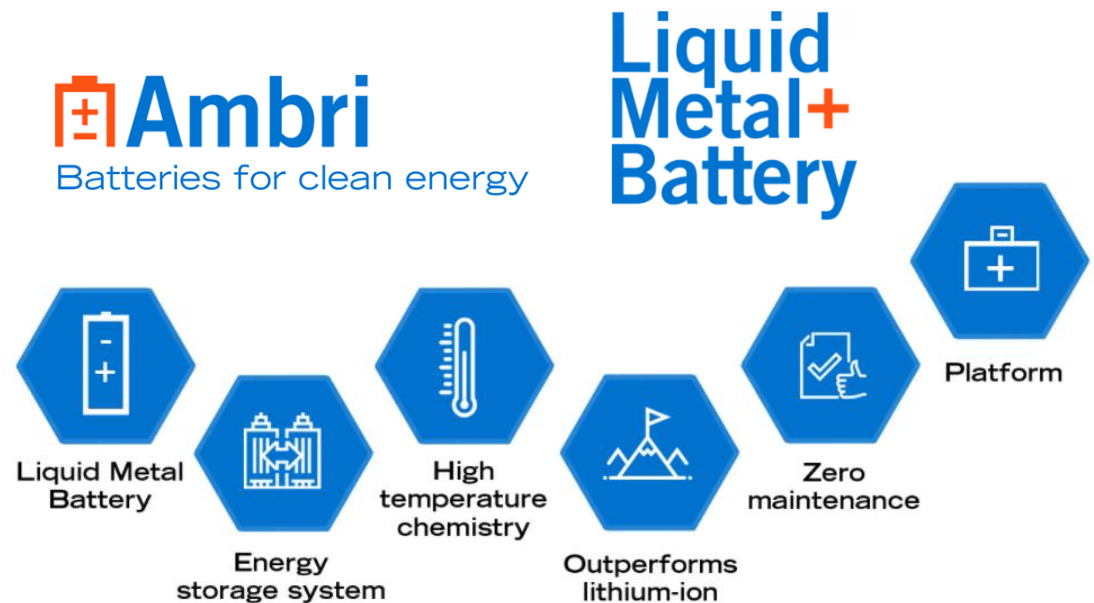

Source: <https://ambri.com/>

## **Redefining how modern mining companies can be part of climate change solutions**

1. Subject to completion of the permitting process for the Project, commencement of commercial production of antimony, identification of one or more refiners to transform our antimony concentrate into antimony metal, and mutual agreement on certain material terms, including volume and pricing. For additional information regarding the risks and uncertainties surrounding our supply agreement with Ambri, see "Forward-Looking Statements" at the beginning of this presentation.



# ANTIMONY-BASED LIQUID METAL BATTERIES

## ABOUT AMBRI:

- Combining technological innovation with commercial application to store energy longer, in a scalable way that will change the way power grids operate
- Low-cost battery comprised of a liquid calcium alloy anode, a molten salt electrolyte and a cathode comprised of solid particles of antimony

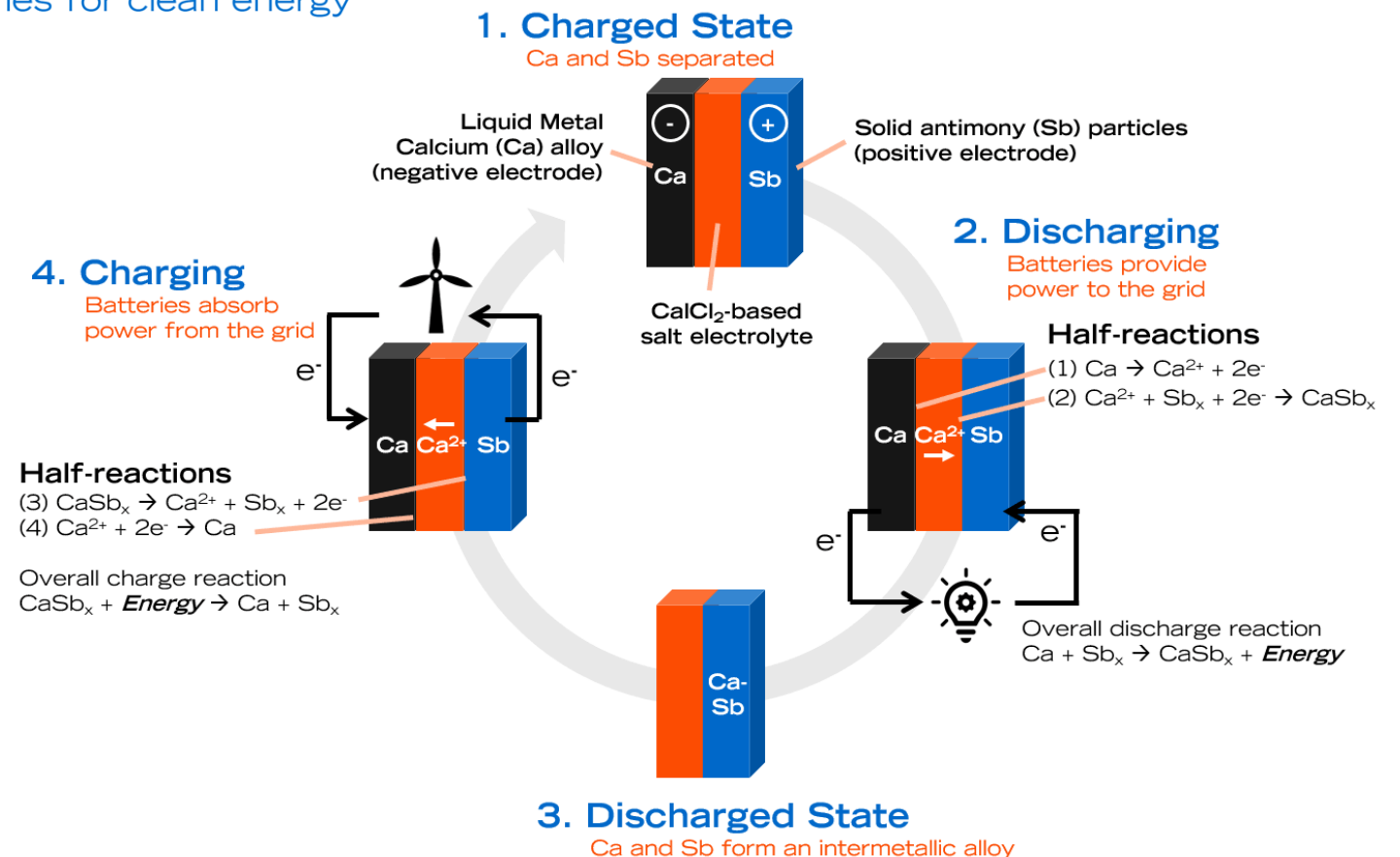

Source: <https://ambri.com/>



# ORE PROCESSING

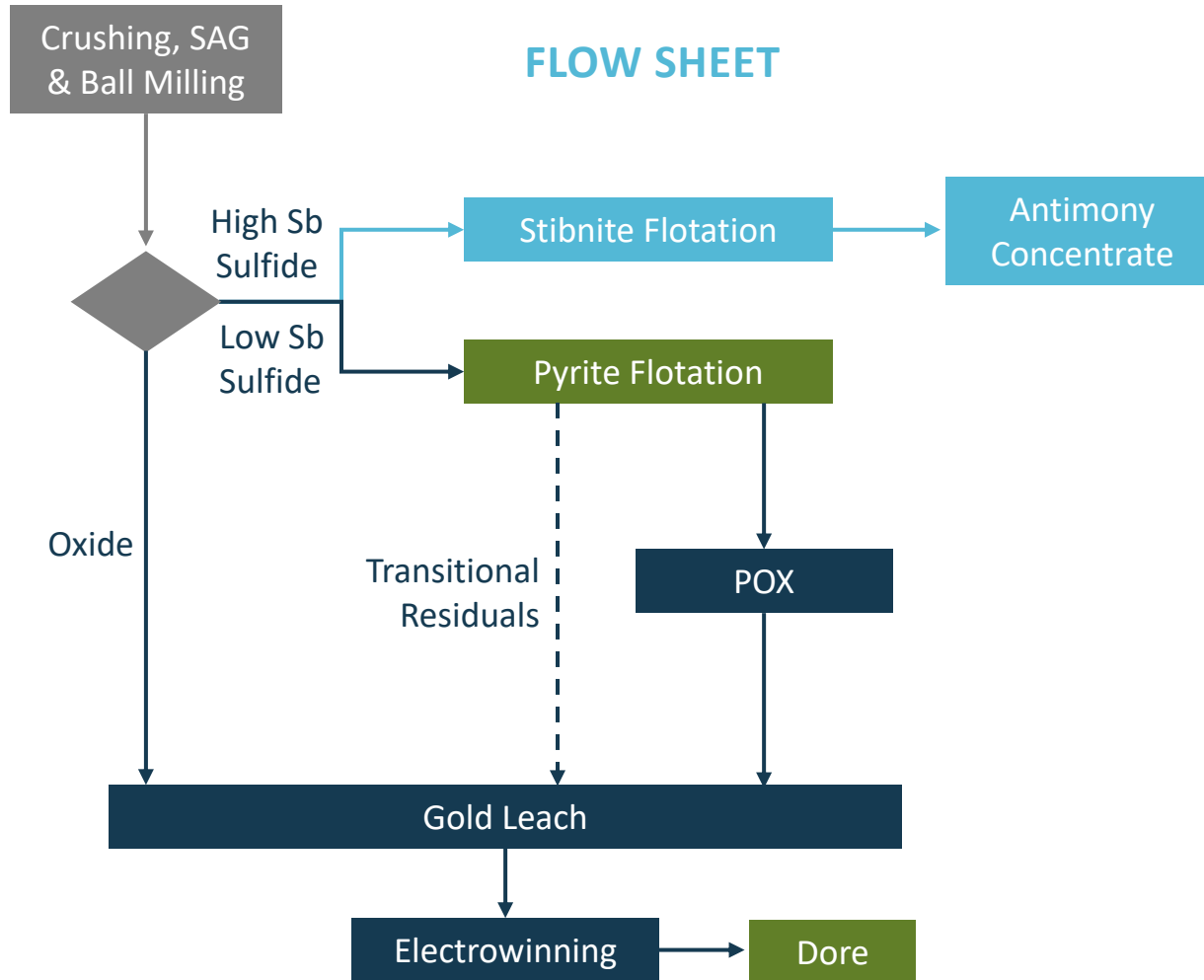

Based on the FS, which is intended to be read as a whole, and sections should not be read or relied upon out of context. The information in this presentation is subject to the assumptions, exclusions and qualifications contained in the Technical Reports. See "Cautionary Note and Technical Disclosure" at the beginning of this presentation.



# FINANCIAL HIGHLIGHTS<sup>1,2</sup>

	Early Production Years 1-4	Life-of-Mine Years 1-15
Recovered Gold Total	1,852 koz	4,223 koz
Recovered Antimony <sup>3</sup> Total	69 Mlbs	107 Mlbs
Average Annual Recovered Gold	463 koz/yr	296 koz/yr
Cash Costs Net of By-Product Credits <sup>4</sup> (\$/oz gold)	\$217/koz	\$537/koz
Total Cash Costs Net of By-Product Credits <sup>5</sup> (\$/oz gold)	\$258/koz	\$583/koz
All-In Sustaining Costs (AISC) Net of By-Product Credits <sup>6</sup> (\$/oz gold)	\$435/koz	\$756/koz
Initial Capital including Contingency <sup>7</sup>	\$2,215 million	
<b>\$2,900/oz gold - \$31.50/oz silver - \$21.00/lb antimony<sup>8</sup></b>		
After-Tax Net Present Value (NPV) at 5% Discount Rate <sup>9</sup>	\$3,650 million	
Annual Average EBITDA <sup>10</sup>	\$1,366 million	\$745 million
Annual Average After-Tax Free Cash Flow <sup>11</sup>	\$1,117 million	\$590 million
After-Tax Internal Rate of Return <sup>12</sup>	27.1%	
After-Tax Payback Period	2.2 years	
<b>\$2,100/oz gold - \$27/oz silver - \$10.00/lb antimony<sup>13</sup></b>		
After-Tax Net Present Value at 5% Discount Rate <sup>9</sup>	\$1,391 million	
Annual Average EBITDA <sup>10</sup>	\$844 million	\$445 million
Annual Average After-Tax Free Cash Flow <sup>11</sup>	\$704 million	\$351 million
After-Tax Internal Rate of Return <sup>12</sup>	15.4%	
After-Tax Payback Period	3.2 years	

- For additional information regarding the Financial Update, including underlying assumptions and risks, see the Financial Update included in the Current Report.
- The Financial Update assumes 100% equity financing.
- Antimony is a chemical element included on the U.S. Interior Department's list of Critical Minerals.
- Cash Costs consist of mining costs, processing costs, mine-level G&A and by-product credits. By-product credits calculated based on consensus pricing. Cash Costs is a non-GAAP measure. See Non-GAAP Measures at the end of this release.
- Total Cash Costs consist of Cash Costs, royalty costs, treatment costs, refining costs, and transportation costs. By-product credits calculated based on consensus pricing. Total Cash Costs is a non-GAAP measure. See Non-GAAP Measures at the end of this release.
- AISC includes Total Cash Costs plus sustaining capital costs. By-product credits calculated based on consensus pricing. AISC is a non-GAAP measure. See Non-GAAP Measures at the end of this release.
- Initial Capital, net, reflects estimated total capital expenditures of \$2,215 million, including a contingency of \$191.9 million, net of \$33.6 million of pre-production revenue.
- Spot prices are defined as \$2,900/oz gold, \$21.00/lb antimony, and \$31.50/oz silver. The precious metals prices selected for this scenario were based on the NYMEX gold and silver settlement prices of \$2,887.60/oz and \$32.44/oz, respectively, on February 7, 2025. The antimony price selected for the spot scenario was based on Rotterdam antimony price as of February 7, 2025.
- Net Present Value (NPV) is defined as the present value of future after-tax cash flows of the project discounted at an annual rate of 5%. The Financial Update assumed a combined state and federal effective tax rate of 26.45%.
- EBITDA consists of total revenue minus operating costs, offsite charges and royalties. EBITDA is a non-GAAP measure. See Non-GAAP Measures at the end of this release.
- After-Tax Free Cash Flow consists of EBITDA as adjusted for changes in net working capital, all capital expenditures (initial, sustaining, and closure capital expenditures), and salvage value, less taxes payable. Free Cash Flow is a non-GAAP measure. See Non-GAAP Measures at the end of this release.
- Internal rate of return (IRR) is defined as the after-tax discount rate at which the net-present value of the project reaches zero. The Financial Update assumed a combined state and federal effective tax rate of 26.45%.
- Consensus prices are defined as \$2,100/oz gold, \$10.00/lb antimony, and \$27.00/oz silver based on a broad range of investment bank forecasts as of December 2024.

Based on the FS and Financial Update, which are intended to be read as a whole, and sections should not be read or relied upon out of context. Financial data as of Q4 2024 as set forth in the Financial Update. The information in this presentation is subject to the assumptions, exclusions and qualifications contained in the Technical Reports. See "Cautionary Note and Technical Disclosure" at the beginning of this presentation.



# STIBNITE GOLD PROJECT COST SUMMARY<sup>1</sup>

Operating Costs	Early Production Years 1-4		Life of Mine Years 1-15	
	US\$/t milled	US\$/oz Au	US\$/t milled	US\$/oz Au
Mining	\$13.3	\$234.2	\$10.2	\$278.5
Processing	\$13.4	\$234.7	\$13.2	\$362.0
G&A	\$4.3	\$72.4	\$4.3	\$117.0
By-Product Credits	(\$18.5)	(\$324.1)	(\$8.0)	(\$220.4)
<b>Cash Cost Net of By-Products<sup>1</sup></b>	<b>\$12.5</b>	<b>\$217.2</b>	<b>\$19.7</b>	<b>\$537.1</b>
Offsite Charges	\$0.3	\$4.7	\$0.1	\$4.0
Royalties	\$2.1	\$36.5	\$1.5	\$42.1
<b>Total Cash Cost Net of By-Products<sup>1</sup></b>	<b>\$14.9</b>	<b>\$258.3</b>	<b>\$21.3</b>	<b>\$583.2</b>
Sustaining Capital Costs	\$10.1	\$177.0	\$6.3	\$173.1
<b>All-in Sustaining Cost (AISC)<sup>1</sup></b>	<b>\$24.9</b>	<b>\$435.3</b>	<b>\$27.6</b>	<b>\$756.3</b>

Capital Costs	Initial CAPEX <sup>2</sup> (US\$M)	Sustaining CAPEX (US\$M)	Closure CAPEX <sup>3</sup> (US\$M)	Total CAPEX (US\$M)
Direct Costs - Mine Costs	183.6	215.4	--	399.0
Direct Costs - Processing Plant	643.7	88.1	--	731.8
Direct Costs - On-Site Infrastructure	336.3	287.8	--	624.1
Direct Costs - Off-Site Infrastructure	295.5	0.4	--	295.9
Indirect Costs and Project Delivery	348.8	--	--	348.8
Mitigation, Monitoring and Closure	11.5	106.0	118.1	235.5
Owner's Costs	227.9	--	--	227.9
Contingency and Sales Tax	201.1	25.8	--	226.9
<b>Sub-total CAPEX</b>	<b>2,248.5</b>	<b>723.5</b>	<b>118.1</b>	<b>3,090.0</b>
Pre-Production Revenue	(33.6)	--	--	(33.6)
<b>Total CAPEX</b>	<b>2,214.8</b>	<b>723.5</b>	<b>118.1</b>	<b>3,056.4</b>

**Notes:**

1. Cash costs, Total Cash Costs, and All-in Sustaining Costs are non-GAAP measures. See "Non-GAAP measures" at the end of this presentation.
2. Initial Capital ("Initial CAPEX") includes capitalized preproduction and is presented net of pre-production revenue assuming a price of \$2,100/oz gold.
3. Defined as non-sustaining reclamation and closure costs in the post-operations period.

Based on the FS and Financial Update, which are intended to be read as a whole, and sections should not be read or relied upon out of context. Financial data as of Q4 2024 as set forth in the Financial Update. The information in this presentation is subject to the assumptions, exclusions and qualifications contained in the Technical Reports. See "Cautionary Note and Technical Disclosure" at the beginning of this presentation.





# ANNUAL AFTER-TAX CASH FLOW (@ \$2,100 GOLD PRICE)<sup>1</sup>

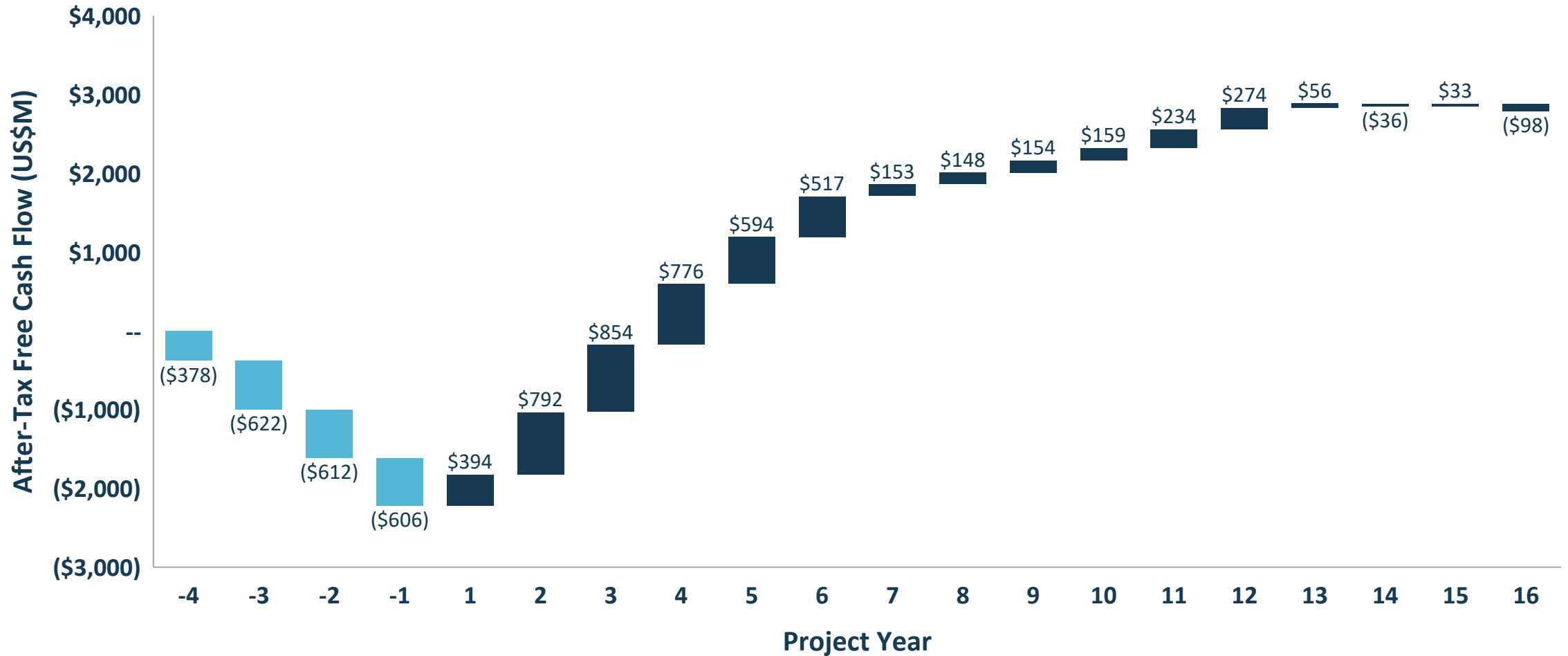

1. Based on the FS and Financial Update, which are intended to be read as a whole, and sections should not be read or relied upon out of context. Financial data as of Q4 2024 as set forth in the Financial Update. The information in this presentation is subject to the assumptions, exclusions and qualifications contained in the Technical Reports. See "Cautionary Note and Technical Disclosure" at the beginning of this presentation.



# SUPPORTIVE SHAREHOLDER BASE

## SHAREHOLDERS\*\*

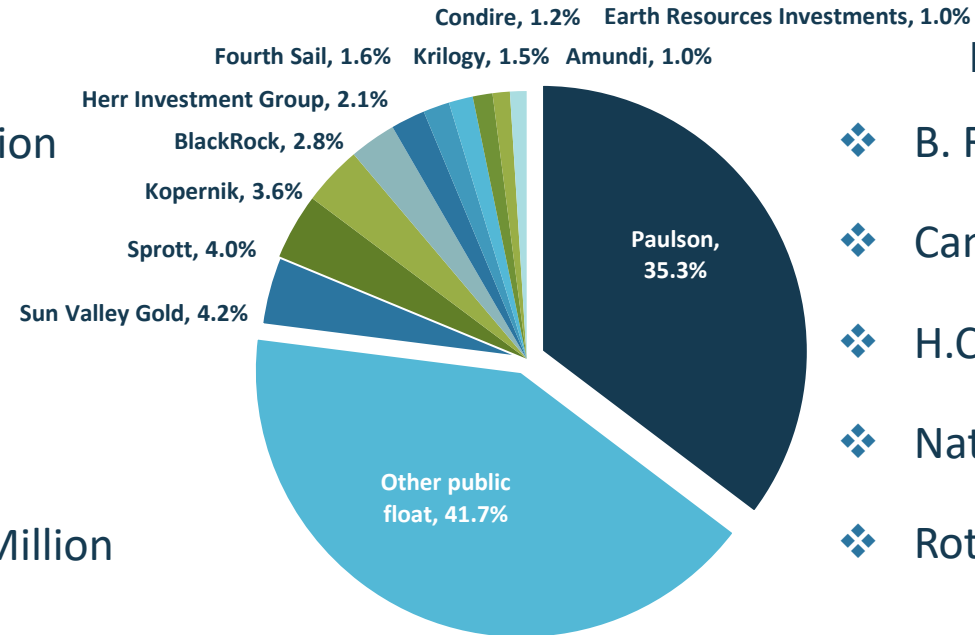

## CAPITAL STRUCTURE\*

- ❖ Issued & Outstanding 70.17 Million
- ❖ Options 0.95 Million
- ❖ Share Units 2.26 Million
- ❖ Fully Diluted 73.37 Million
- ❖ Estimated Cash Balance ~\$44.8 Million

## RESEARCH COVERAGE

- ❖ B. Riley Financial – Lucas Pipes
- ❖ Cantor Fitzgerald – Mike Kozak
- ❖ H.C. Wainwright – Heiko Ihle
- ❖ National Bank Financial – Mike Parkin
- ❖ Roth Capital – Mike Niehuser

\*Capital structure estimate has been adjusted for the net proceeds (\$33.6M) from the November 2024 equity offering and cash & equivalents as of September 30, 2024.

\*\*Based on most recent shareholder filings, percentages reflect common shares outstanding as of September 30, 2024 and the additional 3.4M shares sold through the equity offering in November 2024.



**Perpetua  
Resources**



# REGULATORY INFORMATION

The FS was compiled by M3 Engineering & Technology Corporation (“M3”) in accordance with NI 43-101 under the direction of independent qualified persons (as defined in NI 43-101) (“Independent QPs”). Independent QPs for the FS include: Richard Zimmerman, SME-RM (onsite and offsite infrastructure, cost estimating and financial modeling) and Art Ibrado, P.E. (mineral processing) with M3; Garth Kirkham, P.Geo. (mineral resources) with Kirkham Geosystems Ltd.; Christopher Martin, C.Eng. (metallurgy) with Blue Coast Metallurgy Ltd.; Grenvil Dunn, C.Eng. (hydrometallurgy) with Hydromet WA (Pty) Ltd.; Chris Roos, P.E. (mineral reserves) and Scott Rosenthal P.E. (mine planning) with Value Consulting, Inc.; and Peter Kowalewski, P.E. (tailings storage facility and closure) with Tierra Group International, Ltd.

The TRS was compiled by M3 in compliance with Subpart 1300 promulgated by the SEC under the direction of Independent Qualified Persons (as defined in Subpart 1300) (“QPs”). QPs for the TRS include: Richard Zimmerman, SME-RM (onsite and offsite infrastructure, cost estimating, mineral processing, financial modeling) with M3; Garth Kirkham, P.Geo. (mineral resources) with Kirkham Geosystems Ltd.; Christopher Martin, C.Eng. (metallurgy) with Blue Coast Metallurgy Ltd.; Grenvil Dunn, C.Eng. (hydrometallurgy) with Hydromet WA (Pty) Ltd.; Scott Rosenthal P.E. (mine planning and mineral reserves) with Value Consulting, Inc.; and Peter Kowalewski, P.E. (tailings storage facility and closure) with Tierra Group International, Ltd.

The Financial Update was prepared by the Company under the direction of Christopher Dail, a qualified person (as defined in NI 43-101 and as defined in Subpart 1300), and is based, in part, on the basic engineering work completed by Ausenco, with contributions from other mining engineers and consultants, utilities and financial advisors.

The material scientific and technical information in respect of the Project in this presentation, unless otherwise indicated, is based upon information contained in the FS, with notable differences between the FS and the TRS identified. The financial information in respect of the Project in this presentation, unless otherwise indicated, is based upon information contained in the Financial Update, which should be read as a supplemental financial update to the FS with respect to economic information regarding the Project.

Readers are encouraged to read the Financial Update and the Company’s Current Report on Form 8-K filed with the SEC on February 13, 2025, which is available under the Company’s profile on EDGAR. Readers are encouraged to read the TRS and the Company’s Current Report on Form 8-K filed with the SEC on January 3, 2021, as amended by the Company’s Current Report on Form 8-K/A filed with the SEC on June 8, 2022, which are available under the Company’s profile on EDGAR. Readers also are encouraged to read the FS, which is available under the Company’s profile on SEDAR and on the Company’s website, for detailed information concerning the Project. All disclosure contained in this presentation regarding the mineral reserves and mineral resource estimates and economic analysis on the property is fully qualified by the full disclosure contained in the FS, the TRS and the Financial Update. The FS, the TRS and the Financial Update are intended to be read as a whole and sections should not be read or relied upon out of context.

Financial data is based on cost estimates as of the fourth quarter of 2024, as set forth in the Financial Update. See the Current Report filed on Form 8-K on February 13, 2025.

Information of a scientific or technical nature in this presentation is based on information which has been approved by Christopher Dail, AIPG CPG #10596, Exploration Manager for Perpetua Resources Idaho, Inc. and a qualified person (as defined in NI 43-101 and as defined in Subpart 1300).

All mineral resources have been estimated in accordance with CIM definitions, with notable differences to Subpart 1300 identified. Mineral resources are reported in relation to a conceptual pit shell to demonstrate potential for economic viability, as required under NI 43-101; mineralization lying outside of these pit shells is not reported as a mineral resource. Mineral resources are not mineral reserves and do not have demonstrated economic viability. Mineral resource estimates include inferred mineral resources that are considered too speculative geologically to have economic considerations applied to them that would enable them to be categorized as mineral reserves. It is reasonably expected that the majority of inferred mineral resources could be upgraded to indicated mineral resources.

The mineral resources and mineral reserves at the Stibnite Gold Project are contained within areas that have seen historic disturbance resulting from prior mining activities. In order for the Company to advance its interests at the Stibnite Gold Project, the Project will be subject to a number of federal, state and local laws and regulations and will require permits to conduct its activities.

## OTHER

See also “Cautionary Note” at the beginning of this presentation.

Certain monetary amounts, percentages and other figures included in this presentation have been subject to rounding adjustments. Certain other amounts that appear in this presentation may not sum due to rounding.



# NON-GAAP MEASURES

This presentation includes disclosure of certain non-GAAP financial measures or ratios, including expected Cash Costs, Total Cash Costs, All-In Sustaining Costs (AISC), Average Annual EBITDA and Average Annual Free Cash Flow (FCF) with respect to the expected results of the Project as presented in the Financial Update. The Company uses these measures to evaluate the Company's future operating performance and provide visibility into the economics of our future mining operations. We believe the projected non-GAAP financial measures included in this presentation provide readers with additional meaningful comparisons between the Company's Financial Update and its peer companies. These projected non-GAAP financial measures are not historical measures of financial performance and are not presented in accordance with GAAP. They may exclude items that will be significant in understanding and assessing our financial results. Therefore, these measures should not be considered in isolation or as an alternative or superior to GAAP measures. You should be aware that these measures have no standardized meaning under GAAP and may not be comparable to similarly-titled measures used by other companies.

We define "Cash Costs" as the sum of mining costs, processing costs, mine-level G&A and by-product credits; we define "Total Cash Costs" as the sum of Cash Costs, royalty costs, treatment costs, refining costs, and transportation costs; we define "All-In Sustaining Costs" as the sum of Total Cash Costs and sustaining capital costs (all costs required to sustain operations); we define earnings before interest, taxes and depreciation and amortization (EBITDA) as total revenue minus operating costs, offsite charges and royalties; we define "Free Cash Flow" as EBITDA as adjusted for changes in net working capital, all capital expenditures (initial, sustaining, and closure capital expenditures), and salvage value; and we define After-Tax FCF as FCF less taxes payable. FCF does not entirely represent cash available for discretionary expenditures due to the fact that the measure does not deduct payments required for debt service and other items. Annual averages of non-GAAP measures represent the total value of the non-GAAP measure divided by the number of years during the forecast period.

As the Project is not in production, the prospective non-GAAP financial measures are based on the estimated revenues, costs and other metrics set forth in the Financial Update, and are subject to the assumptions, qualifications and exceptions set forth in the FS and the TRS, as updated by the Financial Update. See the economic model included as Exhibit 99.1 included in the Company's current report on Form 8-K, filed with the SEC and Canadian securities regulators on February 13, 2025, for additional information regarding these measures. The economic model included in the Financial Update is not a true cash flow model as defined by financial accounting standards but rather a representation of Project economics at a level of detail appropriate for a feasibility study level of engineering and design. As such, the projected non-GAAP measures included in this presentation cannot be reconciled to comparable GAAP measures without unreasonable effort.

The non-GAAP financial measures included in this presentation are projections based on the FS and Financial Update. They are forward-looking statements and remain subject to the risks and uncertainties set forth in the section titled "Forward-Looking Statements" at the beginning of this presentation.